Honeywell 10012/1/2 Datasheet



Cambia Automation Limited

Cambia Group
+86 13599507613
sales@cambia.cn
2018/10/24

**Experion LS I/O Specifications and
Technical Data**



EP03-110-400

Release 400

February 2012, Version 2

email: sales@cambia.com

Revision History

Revision	Date	Description
1	January 2011	Release version
2	January 2012	General Update

email: sales@cambia.com

1.	Introduction	1
1.1	I/O Families	1
2.	Chassis I/O – Series A Specifications	2
2.1	Essential Concepts	2
3.	Planning and Platform Details	4
3.1	Implementation Rules and Limits	4
4.	Wiring Options	5
4.1	Terminal Blocks	5
4.2	Wiring Option-2 (RTPs)	5
4.2.1	Terminology and Ordering Information	6
5.	Chassis Series-A Power System	8
5.1	Power Calculations	9
5.2	Series-A Power Supply Specifications	9
6.	General Module Specifications	11
6.1	Summary of Series-A Modules and Model Numbers	13
6.2	Series-A Chassis Summary	14
6.3	Hardware Mounting Options	15
6.4	Miscellaneous Components	15
6.5	Specifications – Traditional I/O Modules	16
6.6	Specifications – Specialty and Network Modules	41
7.	Reference	46
7.1	Module Power Consumption Data	46
8.	DeviceNet Interface	48
8.1	Introduction	48
8.2	Functional Description	49
8.2.1	Introduction	49
8.2.2	DeviceNet Interface Library	49
8.3	Data Formats	53
8.4	Specifications	54
8.5	Configuration	56
9.	PROFIBUS Integration	57
9.1	Introduction	57
9.2	Functional Description	57
9.3	PROFIBUS DP Overview	58
9.4	PROFIBUS Interface Architecture	59
9.5	Stations	60
9.6	Control Processor Integration	60
9.7	Specifications and Capacity	62
9.8	PROFIBUS Cable Characteristics	63
9.9	Configuration Tools	63
9.10	PROFIBUS Licenses	64
9.11	Generic PROFIBUS I/O Blocks	65
9.11.1	Introduction	65
10.	Rail I/O – Series A Specifications	68
10.1	Hardware and Communications Features	68
10.2	Module Specifications	75
11.	ControlNet Communications	95
11.1	Specifications	95
12.	Input Modules	105
13.	Output Modules	118
14.	Power Supply Dimensional Specifications	122
14.1	Power Supply Wiring Diagrams	123
15.	Hazardous Locations Reference	124
15.1	Entity Concept	127
15.2	International Electrotechnical Commission Classification of Hazardous Locations	128
15.3	Enclosure Ratings	130

email: sales@cambia.com

1. Introduction

1.1 I/O Families

Experion provides three I/O families that can be used in conjunction with the C200E/C200 control processor. The table below lists each family along with major characteristics.

Figure 1-1 Experion LS I/O Families



Table 1-1 I/O Family Summary and Description

I/O Family (Source)	Mounting Type/style	Major Features and Distinguishing Characteristics
CIOM-A	Chassis	Wide variety of I/O types and chassis sizes Good Backplane robustness (but non-redundant) Good quality I/O when redundancy is not required
RIOM-A	Din Rail	Inexpensive installation and wiring Flexible mounting configurations

2. Chassis I/O – Series A Specifications

2.1 Essential Concepts

Experion Chassis Series-A Modules and Platform

Chassis Input/Output Modules-Series A (CIOM-A) is a chassis based platform. Modules exist in a single-wide and double-wide form factor. Modules are inserted into chassis slot positions; single-wide occupy one slot position while double-wide modules occupy two slots. As a platform, the chassis is host to not only I/O modules, but modules that perform other functions.

Some examples include:

- C200E Control Processor
- Redundancy Module (RM)
- Battery Extension Module
- ControlNet Interface Module (CNI)
- Ethernet Module

The I/O modules are the focus of this document. Other module types are covered in separate Specification documents.

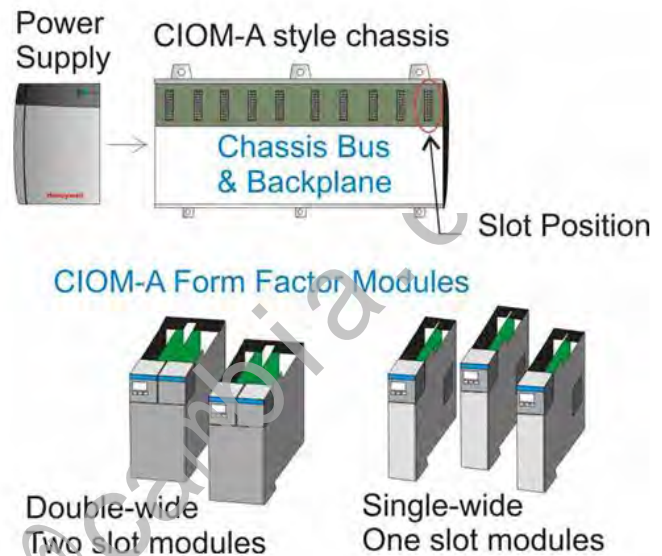

Figure 2-1 Experion Chassis Series

Power

Module power is supplied by a Series-A specific power supply. Power supplies are available in a redundant and non-redundant configuration. The power module plugs to the left side of each chassis and does not consume a chassis slot position. The power supply provides DC power for the modules inserted into the chassis. Field power is provided by separate (external) power supplies.

Series-A Chassis Types

Chassis differ by the number of module positions or slots that the given chassis can accommodate. Chassis come in five versions (4, 7, 10, 13, and 17 slot). Some modules are double-wide and will use two chassis positions.

Model Number Conventions (TC and TK)

All model numbers are preceded by a **TC-** or a **TK-**. The TC designator indicates that the module is not conformal coated while the TK designator indicates that the module has conformal coating applied. Aside from this the modules are identical.

Supported Control Processors

All CIOM-A I/O modules are usable with the C200E control processor.

C200E and the I/O ControlNet

Figure 3-1 shows how CIOM-A modules interface to the C200E control processor over the I/O Control Network. ControlNet is an open communication protocol developed by Rockwell and is based on RG-6 coax at 5 mega bit transmission speed. Coax segments can be extended using repeaters and fiber optic modules. Although the media can be redundant, the interface modules have a single set of electronics for both A and B cables.

The C200E or Downlink Chassis: This is the chassis that has the C200E inserted. It is also referred to as the “Downlink” chassis because it has the CNI (ControlNet Interface) modules that connect the C200E to the various remote I/O modules. The user can insert up to four total “Downlink” CNIs to create four separate I/O network routings. This provides the flexibility to create from one to four different I/O network branches.

Redundant C200E: When the C200E is implemented in a redundant configuration there are two chassis with an identical set of modules installed in the same physical positions.

Mixed I/O Families: As the figure, shows, CIOM-A I/O modules can be implemented on the same I/O Control Network as the RIOM-A module type. RIOM-A module are interfaced to the I/O CNet through ControlNet Gateway modules and the CIOM-A modules are interfaced through the CNI module.

Downlink and Uplink CNIs: There are only two versions of the CNI (single media and dual media). The terms uplink and downlink are assigned based on the CNI location in the topology.

I/O ControlNet Limits:

Item	Limit	See
Maximum number of CNI modules/Downlink chassis	4	
Maximum number of uplink CNI's (I/O chassis) and Gateways per downlink CNI	8	
Maximum number of I/O units per downlink CNI	24	Note-1
Maximum I/O units per C200E	64	Note-1 & 2
Note-1: In most cases an I/O unit is one I/O module. Some module types (like the SI and Profibus module) will consume more than one I/O unit.		
Note-2: PMIO (connected through the IOLIM) will also consume this resource.		

3. Planning and Platform Details

3.1 Implementation Rules and Limits

Redundant C200E Configurations: When the C200E is implemented in a redundant configuration no I/O modules can be inserted into the C200 chassis.

Non-Redundant C200E Configurations: When the C200E is non-redundant, I/O modules can be inserted into the C200 chassis.

Remote I/O Chassis: The “Remote I/O” chassis is located remote to the C200E chassis and on one of four possible I/O ControlNet branches. The remote I/O chassis has one CNI (single or dual media) to provide the interface to the CNet and is populated with the desired mix of I/O modules up to the maximum available slot positions.

I/O Module/Channel Identification: The I/O modules are identified by the assigned CNI MAC (network) address number and the physical position of the I/O module in the chassis (0 to the maximum number of slots). Each input and output is then referenced by its unique channel number (0 to the maximum number of channels).

Supervisory Control Network: Depending on the network type used this interface module could be a CNI or Ethernet or module.

RIUP: Modules can be removed and inserted under power (user must also comply with all zone/location certifications and safety requirements).

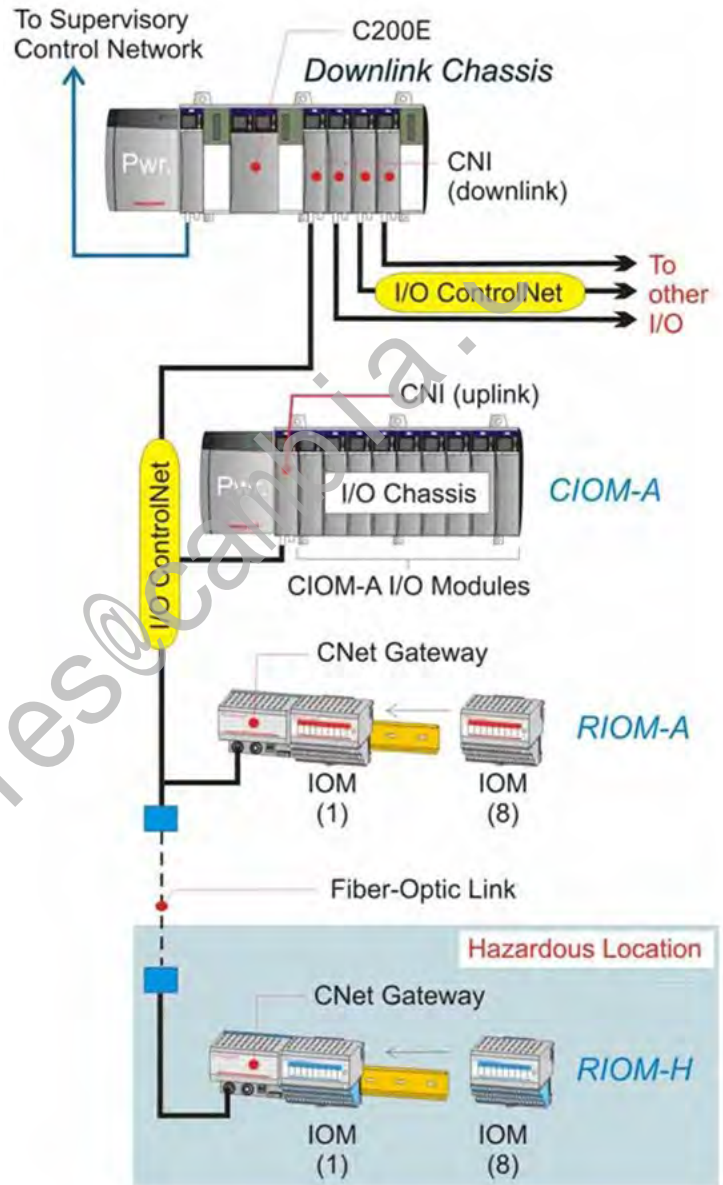
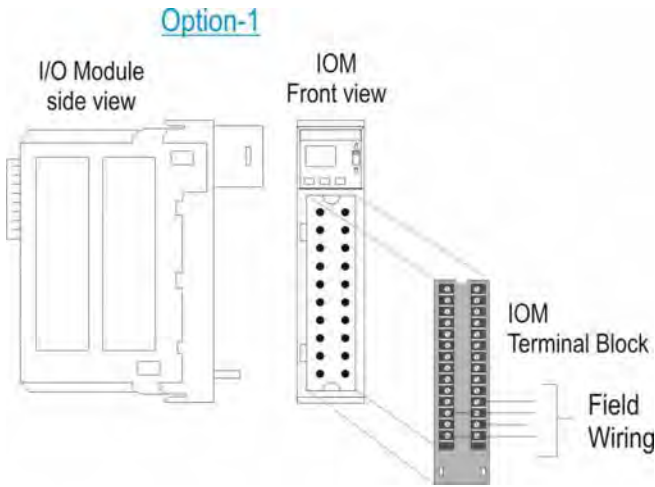

Figure 3-1 I/O Control Network Overview

4. Wiring Options

There are two methods available to connect field wiring to a Series-A IOM (I/O module).



Wiring Option-1 (Standard Terminal Blocks)

This option involves plugging in the standard removable terminal block (TB) into the front of the I/O Module. Depending on the IOM selected, these blocks come with (20) or (36) terminal connectors. Field wiring is then terminated directly on the TB.

As the block is removable, wiring can be done ahead of time and before the IOM is delivered on site. TBs are available separately.

4.1 Terminal Blocks

Table 4-1 - Terminal Blocks, Cables and Connector Sizes

Description	Model Number	Wire Size Range
<i>I/O Module Terminal Blocks</i>		
I/O Module Field Wiring Conn., 20 pin	TC-TBNH	1 wire @ 14-22 AWG (0.64-1.63 mm) or 2 wires @ 16-22 AWG (0.64-1.30 mm)
I/O Module Field Wiring Conn., 36 pin	TC-TBCH	1 wire @ 16-22 AWG (0.64-1.30 mm)

Note: See **Table 6-2: Standard/Traditional I/O Modules & Model Numbers** for a listing of modules and required TB types.

4.2 Wiring Option-2 (RTPs)

This option involves connecting a pre-wired terminal block (same as the 20/36 pin blocks used for Opt-1 above) to a multi-conductor cable assembly. The TB and pre-wired cable connects the IOM to a remote termination panel (RTP). Field wiring is then terminated on the RTP terminal blocks.

This solution is purchased as two separate components:

- The **Cable Assembly** (includes the IOM TB, TB cover, and pre-wired cable assembly).
- The Din mountable RTP.

There is a comprehensive selection of different RTPs and cable assemblies based on the IOM type and required input or output wiring. In many cases, there are more than one cable and RTP that can be used with a given IOM. The user specifies the cable length as part of the catalog number.

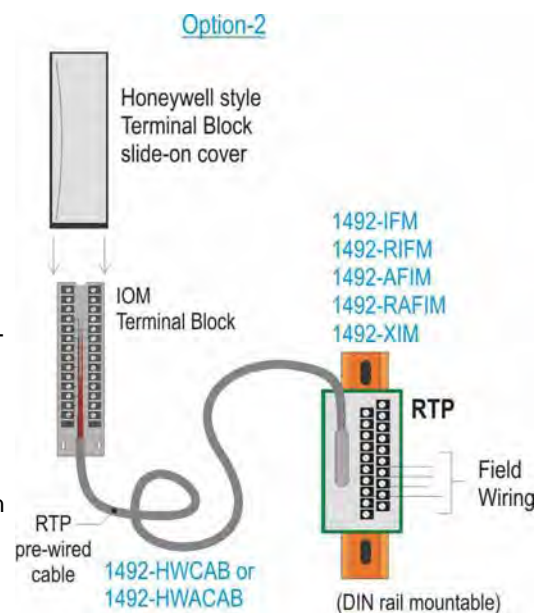

Sourcing: RTPs and pre-wired cable assemblies are purchased directly from Rockwell Automation (Allen-Bradley).

All components are part of the A-B 1492 I/O wiring system and all catalog numbers begin with 1492 followed by alpha-numeric characters that indicate desired features and options.

4.2.1 Terminology and Ordering Information

Cables: Except for the style of "Slide-on Cover" supplied the pre-wired cable assembly used for A-B I/O modules and Honeywell I/O modules are identical. All Honeywell cables must have the HW designator in the catalog number.

Basic pre-wired Cable Assembly catalog numbers:

- 1492-CABLE-Cable Assembly for Digital (discrete) IOM's (A-B Slide-on Cover supplied)
- 1492-ACABLE-Cable Assembly for Analog IOM's (A-B Slide-on Cover supplied)
- 1492-HWCAB-Cable Assembly for Digital (discrete) IOM's (Honeywell style Slide-on Cover)
- 1492-HWACAB-Cable Assembly for Analog IOM's (Honeywell style Slide-on Cover)

Example catalog number:-1492-HWACAB ### UB

1492-HWACAB Indicates an analog IOM cable supplied with a Honeywell style cover.

The ### indicates the desired cable length in meters. Two standard lengths are provided (use 010 for one meter or 3.28 feet) and (025 for 2.5 meters or 8.2 feet). Custom cable lengths up to 99 meters (324.72 feet) can be specified.

UB indicates the wiring layout (In this case a cable pre-wired for module TC-IAH161 and single ended current inputs). Different letter designators are used with other IOM's.

RTPs: Honeywell always refers to the Din rail mountable terminal assembly as an **RTP** (Remote Terminal Panel). Rockwell uses the acronyms IFM, RIFM, AIFM, RAIFM, or XIM.

The Rockwell catalog numbers begin with 1492- followed by alpha-numeric characters that indicate desired features, options, and associated IOM.

When ordering RTPs, the following RTP catalog numbers are used:

- 1492-IFM - Identifies an RTP for use with Digital (discrete) I/O
- 1492-RIFM - Same as IFM with removable terminal blocks
- 1492-AIFM - Identifies an RTP for use with Analog I/O
- 1492-RAIFM - Same as AIFM with removable terminal blocks
- 1492-XIM -Identifies a "Relay Expander Module" that provide relays on the RTP for use with Digital Output IOM's

Example catalog number: - 1492-AIFM6TC-3

This RTP is use with the 6 channel TC-IXL062 T/C input module.

Relay and Expandable Interface Modules (XIM) provide additional flexibility for discrete output type IOM's (TC/TK-ODD321 and TC/TK- ODA161). They were developed to maximize the effectiveness of user applications that require output contact ratings greater than 2 A. Driving large loads up to 10 A for applications such as motor starters is now possible using these relay type RTPs.

In addition, the relay modules provide a means to isolate output points. The relay and expandable product line consists of a relay master module and expander module(s) with expander cable. The relay master modules provide the connection for the 20- or 40-pin cable connectors for the pre-wired cable. There are three types of expander XIMs: eight-channel relay, eight-channel fused, and eight-channel feed-through. Expander module capabilities are offered in eight-channel increments. After using 8 or 16 channels of I/O for relays (master relay module), design engineers can use expander modules for the other I/O point needs. The flexibility means that they work with relays, fuses, and feed-through modules. In addition, the expander modules can be added when system expansion is required.

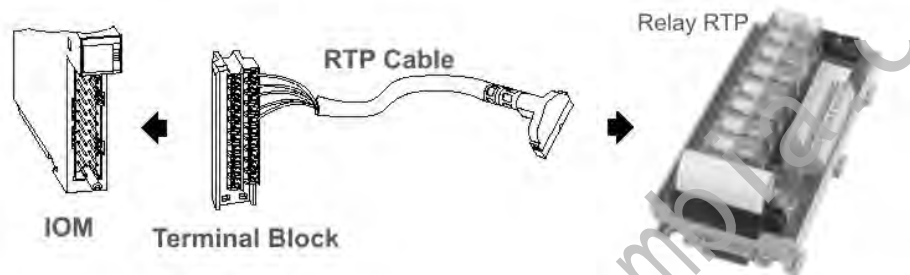

Important Notes and Guidelines:

1. RTPs and cables are manufactured by and are ordered directly from Allen-Bradley (A-B). Always refer to the A-B web site for the most up-to-date RTP/Cable information.
2. Detailed information (specifications, certifications, warnings, and wiring diagrams) can be accessed from the Allen-Bradley Web site. Reference the Bulletin 1492 wiring systems. Please refer to Allen-Bradley Bulletin 1492 PLC/SLC Wiring System Product Line for digital RTPs/cables and Bulletin 1492-AIFM for Analog RTP and cable specifications and size details.
3. When using RTPs with an IOM, it is not necessary to order a separate TC-TBNH or TC-TBCH terminal block. This component comes with the RTP Cable assembly.
4. All RTPs are mountable on standard DIN #3 rail mounting for quick installation.
5. Always use the HW designator in catalog numbers for cables that will be used with Honeywell I/O Modules. This ensures that the Honeywell style slide-on cover will be supplied.

5. Chassis Series-A Power System

There is a non-redundant and redundant version of the power supply system.

Non-Redundant Power Supply

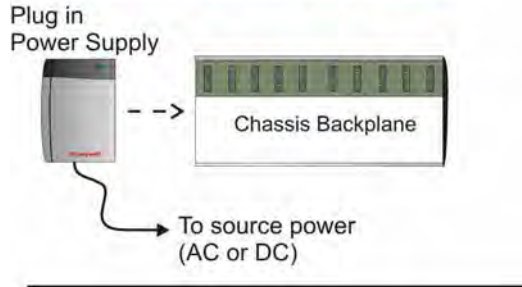

Non-Redundant Power: With this implementation a Chassis Series-A power supply module slides onto the left side of the chassis. This connects the DC output voltage to the chassis backplane and powers all modules that are inserted into one of the chassis slot positions. There is a version that accepts AC source power and a version that accepts DC source power.

Redundant Power Supply

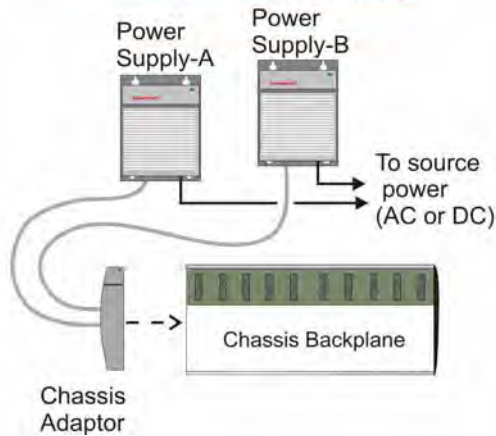

Redundant Power: With this implementation two panel mounted Chassis Series-A power supplies are connected to the chassis through a chassis adaptor module that connects to the left side of the chassis. If one power supply fails, the other will carry the load. There is a version that accepts AC source power and a version that accepts DC source power.

PMIO Power System Redundancy: The PMIO platform provides a fully redundant and robust power supply assembly. This supply generates 24 Vdc and can be used to as the source power for a DC type Chassis-A power supply.

Redundant Power System Versions: There are two versions of the redundant power system. They differ by the cables and chassis adaptor (power supplies are the same). Older versions may exist in the field, but they are no longer available for sale. The table below shows the old and new versions and associated model numbers.

Model No.	Description	No. req.	Notes
TC or TK-	RPDXX1 24 Vdc Power Supply	2	Usable with both versions.
TC or TK-	RPCXX1 120 Vac Power Supply	2	Usable with both versions.
TC-	PRSC03 Power Cable (female connector both ends)	2	Old version- not available.
TC or TK-	RPSCA1 Chassis Adaptor (male connector)	1	Old version- not available.
TC-	PRSC04 Power Cable (female connector for power supply male connector for adaptor)	2	New version – active.
TC or TK-	RPSCA2 Chassis Adaptor (female connector)	1	New version – active.

Note: all power cables are 1 meter long.

5.1 Power Calculations

The Chassis Series-A power supply provides 24 Vdc, 5 Vdc, 3.3 Vdc, and 1.2 Vdc. Each module that is inserted into the chassis will consume a portion of the available power. The user must ensure that the planned configuration and mix of modules does not exceed the capability of the power supply. See power consumption section “Module Power Consumption Data”.

5.2 Series-A Power Supply Specifications

Table 5-1 – Standard (non-redundant) Power Supply Modules

Model	Uncoated:	TC-FPCXX2	TC-FPDXX2
	Coated:	TK-FPCXX2	TK-FPDXX2
Input Voltage Range		85-132 VAC or 170-265 VAC (selectable)	19.2-32 VDC ¹
Input Power ²		150 VA, 92 W	100 W
Maximum Inrush Current		15 A	30 A
Frequency Range		47-63 Hz	DC
Total power output maximum, watts		70 W @ 60 °C	70 W @ 60 °C
Backplane Output Current, Maximum ³		1.5 A @ 1.2 V 4 A @ 3.3 V 10 A @ 5.1 V 2.8 A @ 24.0 V	
Fuse Protection ⁴		non-replaceable fuse is soldered in place	
Wiring		#14 AWG (1.4 mm)	
Dimensions (L x D x H)		11.2 x 14.5 x 14.0 cm (4.41 x 5.71 x 5.51 in)	
Weight – Approximate		1.1 kg (2.5 lb.)	
Location		Left side of chassis (does not consume a slot)	
<ol style="list-style-type: none"> Input may drop to 16 V for a maximum of 2 minutes each hour for motor starting. Note earlier models were rated as follows: TC-FPCXX1 -- 55 W @ 60°C; 70 W @ 45°C and TC-FPDXX1 -- 50 W @ 60°C; 70 W @ 40°C. The combination of all output power (5 V backplane, 24 V backplane, 3.3 V backplane and 1.2 V backplane) cannot exceed 70 W. This fuse is intended to guard against fire hazard due to short circuit conditions and may not protect the power supply from damage under overload conditions. 			

Table 5-2 Redundant Power Supply Modules

Model	Uncoated:	TC- RPCXX1	TC- RPDXX1
	Coated:	TK- RPCXX1	TK- RPDXX1
Input Voltage Range		85 – 265 VAC	16 – 32 VDC
Input Power		110VA, 110 W (estimated)	110 W (estimated)
Maximum Inrush Current		20 A	30 A @ 19 – 32 VDC
Frequency Range		47 – 63 Hz	DC
Total power output maximum, watts		75 W @ 60 C	75 W @ 60 C
Backplane Output Current, Maximum ¹		1.5 A @ 1.2 V 4 A @ 3.3 V 13 A @ 5.1 V 2.8 A @ 24.0 V	
Input Power Wiring		#14 AWG (1.4 mm)	
Annunciation User Connection ²		Solid state relay rated for 120 VAC/DC at 100ma maximum	
Dimensions (L x D x H)		14.4 x 13.7 x 17.5 cm (5.67 x 5.39 x 6.89 in)	
Weight – Approximate		1.1 kg (2.5 lb.)	
Redundant Power Supply Cable Model (3ft)		TC-RPSC03 (one required per power supply)	
Power Supply Cable Weight – Approximate		0.57 kg (1.25 lb.)	
Location ³		Upright mounting, typically above/below chassis to be powered.	
1. The combination of all output power (5 V backplane, 24 V backplane, 3.3 V backplane and 1.2 V backplane) cannot exceed 75 W. 2. In order to pass certain input power surge testing for CE certification, the length of the wiring from this relay must be limited to ten (10) meters. 3. It is not recommended to mount the power supply above/below its partner power supply as this could create ambient temperatures that are greater than 60 C within 1.0 inch of the bottom of the power supply.			

Table 5-3 Redundant Power System Chassis Adaptor





Model	Uncoated:	TC-RPSCA2
	Coated:	TK-RPSCA2
Dimensions (L x D x H)		3.4 x 14.4 x 15.0 cm (1.34 x 5.67 x 5.91 in.)
Weight – Approximate		0.228 kg (0.50 lb.)
Location		Left side of chassis (does not consume a slot)
Environmental Conditions		See Table 3.
Chassis compatibility ¹		TC-FXX042, TC-FXX072, TC-FXX102, TK-FXX102, TC-FXX132, TK-TXX132, TC-FXX172
1. The Chassis Adapter Module will only mount to Chassis model numbers identified above due to a physical interlock. These chassis models are rated for the 13 A supplied by the redundant power supplies. Earlier versions of the chassis were only rated for 10 A.		

The Redundant Power Supply System is designed with the following features:

- Current Sharing Control between each supply – for maximum power supply life
- Error Detection – for maximum security
- Error Annunciation – for immediate notification
- LED Indication – indicating redundant, non-redundant, and failure conditions

6. General Module Specifications

Table 6-1 General Environmental and Agency Certifications

Parameter	Specification	
Environmental Conditions	0 to 60 °C (32 to 140°F) -40 to 85°C (-40 to 185°F) 5 to 95% noncondensing ≤ 1°C/min. (≤ 5°C/min. storage)	
Coated Models (TK-xxxxx) ²	Mild (G1) Moderate (G2) or Harsh (G3)	
	Operative and Storage Limits	Transportation Band
Vibration (3 axes)		
Frequency	10 to 60 Hz	10 to 60 Hz
Acceleration	0.5 g max.	1 g max.
Displacement	0.1 inches	0.1 inches
Mechanical Shock		
Acceleration	5 g max.	20 g max.
Duration	30 ms max.	30 ms max.
Barometric Pressure	-300 to +3000 m	
Altitude	Any	
Agency Certification (when product is marked)	 UL 508 Industrial Control Equipment  Class I, Div 2, Groups A, B, C & D Hazardous and Ordinary locations (Maintenance may require a hot work permit)  89/336/EEC, EMC Directive EN 50081-2, Emissions, Industrial EN 50082-2, Immunity, Industrial  (C-Tick) Meets requirements of the Australian Radiocommunications Act of 1992, Section 182, relating to electromagnetic compatibility.	
Removal/Insertion Under Power (RIUP)	<p>NOT PERMITTED when equipment is installed in a Class I, Division 2, Hazardous (Classified) Location.</p> <p>PERMITTED when equipment is installed in ordinary, non-hazardous, locations (I/O modules reload automatically)</p>	
<p>The above environmental and agency specifications apply to all Experion Chassis Series A models, including Controllers, Power Supplies and I/O, except where noted.</p> <ul style="list-style-type: none"> • The maximum relative humidity specification applies up to 40°C. Above 40°C the RH specification is de-rated to 55% to maintain constant moisture content. • With an enclosure. • The 1/2AA Control Processor Lithium Battery (TC-BATT01) has a non-restricted classification due to its size. It can be shipped without any special documentation or note on the shipping list. The battery is specified for operation from -55 °C to +85 °C. 		

CE-Mark Approval. The C200 and Series-A I/O system fully meet stringent industrial CE-Mark (European Community) immunity and emissions requirements.

Conformal Coating Corrosion Protection. Corrosion is one of the leading failure mechanisms of electronic boards in harsh environments. To insure the maximum possible reliability in corrosive industrial environments, Honeywell provides an optional conformal coating solution. Conformal coating is highly recommended for any installations for which the ambient environment meets either Moderate (G2) or Harsh (G3) conditions as defined by *ANSI/ISA-S71.04-1985, "Environmental Conditions for Process Measurement and Control Systems: Airborne Contaminates."*

Chassis Series-A Model Numbers beginning with a TK- have conformal coating applied. Model numbers beginning with TC- do not.

email: sales@cambia.com

6.1 Summary of Series-A Modules and Model Numbers

Table 6-2: Standard/Traditional I/O Modules & Model Numbers

Module Description (All modules below are single-wide modules)	No. of I/O Channels	No. of TB Pins (1)	Honeywell Model (2) TC or TK-
<i>Analog Input and Output</i>			
High Level Analog Input, (10V & 4-20ma)	6	20	IAH061
Analog Output, (4-20ma)	6	20	OAH061
Analog Output, (10v)	6	20	OAV061
Thermocouple Input <i>see note (4)</i>	6	20	IXL061
Thermocouple Input	6	20	IXL062
RTD Input	6	20	IXR061
Analog Input, Voltage and Current	16	36	IAH161
Analog Output, Current/Voltage	8	20	OAV081
Analog Input, Voltage/Current/HART enabled	8	36	HAI081
Analog Output, Voltage/Current/HART enabled	8	20	HAO081
<i>Isolated Discrete Relay</i>			
24-220 VAC Output (8 NO & 8 NC)	8	36	ORC081
24-220 VAC Output (16 NO)	16	36	ORC161
<i>AC Input (Discrete)</i>			
120 VAC, (Isolated)	16	36	IDK161
220 VAC, (Isolated)	16	36	IDW161
120 VAC, (Diagnostic)	8	20	IDX081
120 VAC	16	20	IDA161
120 VAC (2 Isolated Groups)	32	36	IDB321
<i>AC Output (Discrete)</i>			
120/220 VAC, (Isolated)	16	36	ODK161
120 VAC, (Diagnostic)	8	20	ODX081
120/220 VAC,	16	20	ODA161
<i>DC Input (Discrete)</i>			
24 VDC (Isolated)	16	36	IDJ161
10-30 VDC (Diagnostic)	16	36	IDX161
24 VDC	32	36	IDD321
<i>DC Output (Discrete)</i>			
24 VDC (Isolated)	16	36	ODJ161
10-30 VDC (Diagnostic)	16	36	ODX161
24 VDC	32	36	ODD321

Table 6-3: Chassis - Series A Network and Specialty I/O Module Model Numbers

Description	Chassis Slots Used	Model Number
Specialty Modules		
PI (High Speed Pulse Input). 8-high speed counter inputs & 2- On/Off outputs. This module uses a 36 pin Terminal Block (TC-TBCH). Corresponding A-B model number is 1756-IJ4.	1	TK-MDP081
SI (Serial Interface) module. Provides 2-Serial Channels to communicate with smart devices.	2	TC or TK-MUX021
C200 Control Processor For complete information, consult the C200 Specification document.	2	TK-PRS021
RM (Redundancy Module) to support C200 redundancy	2	TK-PRR021
Communication/ Network/ Gateway Modules		
PBIM (PROFIBUS DP Interface Module) <i>Order directly from SST</i> For complete information, consult the PBIM Specification document.	1	SST-PFBCLX
DeviceNet Bridge Module. <i>Order directly from Allen-Bradley</i> For complete information, consult the DeviceNet Specification document.	1	1756-DNB
IOLIM (I/O Link Module), Interface for PMIO. For complete information, consult the PMIO Specification document.	2	TK-IOLI01
CNI (Single media Type)	1	TC-CCN014
CNI (Dual Media Type)	1	TC OR TK-CCR014
Ethernet Module	1	TK-FTEB01

6.2 Series-A Chassis Summary

Table 6-4 – Series-A Chassis Types & Specifications

Table 7. TC-FXX041, TC-FXX071, TC-FXX102, TC-FXX132, TC-FXX171, TK-FXX101, TK-FXX131			
Model	Module slots	Dimensions (with mounting tabs & power supplies) W x H x D	Approx. weight (without modules)
TC-FXX042	4	26.3 x 16.9 x 14.5 cm (10.3 x 6.7 x 5.8 in)	0.75 kg (1.6 lbs)
TC-FXX072	7	36.8 x 16.9 x 14.5 cm (14.5 x 6.7 x 5.8 in)	1.1 kg (2.4 lbs)
TC-, TK-FXX102	10	48.3 x 16.9 x 14.5 cm (19.0 x 6.7 x 5.8 in)	1.45 kg (3.2 lbs)
TC-, TK-FXX132	13	58.8 x 16.9 x 14.5 cm (23.1 x 6.7 x 5.8 in)	1.9 kg (4.2 lbs)
TC-FXX172	17	73.8 x 16.9 x 14.5 cm (29.1 x 6.7 x 5.8 in)	2.2 kg (4.8 lbs)
Minimum Chassis-to-Cabinet Vertical Distance		15.2 cm (6.0 in)	
Minimum Chassis-to-Cabinet Horizontal Distance		10.2 cm (4.0 in)	
Minimum Chassis-to-Chassis Vertical Distance		20.3 cm (8.0 in)	
Minimum Chassis-to-Chassis Horizontal Distance		10.2 cm (4.0 in)	
Type of mount		Panel mount	
Environmental Conditions Agency Certification		Same as Power Supply Specifications	
Minimum Enclosure Depth		20.3 cm (8.0 in)	

6.3 Hardware Mounting Options

Note that in order to comply with applicable regulations and codes, the controller and I/O racks may have to be located in a room, vault, or enclosure that is accessible only to qualified persons. Please refer to NEC 110-17, part 1 (1996 National Electrical Code, Copyright 1995 NFPA) or to the appropriate local or national electrical standards for more information.

Table 6-5 Chassis Dimensions

Chassis Type (No. of Slots)	Dimensions (HxWxD), Approx. (Note-1)
4	137 x 263 x 145 mm (5.4 x 10.4 x 5.8 in.)
7	137 x 368 x 145 mm (5.4 x 14.5 x 5.8 in.)
10	137 x 483 x 145 mm (5.4 x 19.0 x 5.8 in.)
13	137 x 588 x 145 mm (5.4 x 23.2 x 5.8 in.)
17	137 x 738 x 145 mm (5.4 x 29.1 x 5.8 in.)
Note-1: All dimensions include the chassis and power supply assembly.	

6.4 Miscellaneous Components

The following blank cover module is used to cover an empty slot in the chassis.

Model Number	Description
TC-XXXXX2	Blank Cover Modules (Qty 1). These are covers that clip into used chassis slot positions.

6.5 Specifications – Traditional I/O Modules

TC-IAH061, TK-IAH061

Table 6-6 High Level Analog, 6-Input, Voltage and Current (10 V & 4-20 mA) Module

Parameter	Specification
Number of Points	6 galvanically isolated channels
Input Voltage Range (Voltage) Input Current Range (Current)	± 10.50 VDC maximum 0 to 21.0 mA (w/249 Ω resistor)
Voltage Resolution ± 10.5 volt range 0 to 10.5 volt range 0 to 5.25 volt range Current Resolution	16 bits across each range shown below 343 μ V typical (15 bits + sign) 171 μ V typical 86 μ V typical 0.34 μ A
Input Impedance (Voltage) (Current)	Greater than 10 M Ω 249 Ω
Open Circuit Detection Typical OC Detection Time	Upscale reading (Voltage); Zero scale reading (Current) 5 seconds (Voltage); 1 sec (Current)
Normal Mode Noise Rejection Common Mode Rejection	Greater than 60 dB @ 60 Hz 120 dB @ 60 Hz, 100 dB @ 50 Hz
Channel Bandwidth	0 to 15 Hz (-3 db)
Settling Time to 5% of Full Scale	Less than 80 milliseconds
Calibrated Accuracy @ 25°C	Better than 0.1% of range (Voltage); better than 0.15% of range including 0.05% sense resistor (Current)
Module Update Rate for All Channels	25 ms
RFI Immunity	Error of less than 2.0% of range at 10 V/m, 27 to 1000 MHz
Overvoltage Capability	120 VAC/VDC continuous at room temperature (Voltage); 8 VAC/DC with on-board current resistor (Current)
Input Offset Drift with Temperature	2 μ V/°C typical (Voltage) 8.0 μ V/°C typical (Current)
Gain Drift with Temperature	35 ppm/°C typical (Voltage); 45 ppm/°C typical (Current)
Power Dissipation	4.3 W max
Backplane Current	See Module Power Consumption Data, page 46.
Isolation Voltage Channel to channel User to system	100% tested at 2546 VDC for 1 second 100% tested at 2546 VDC for 1 second
Connection Terminal Blocks	TC-TBNH, 20-position terminal block

TC-OAH061, TK-OAH061**Table 6-7** Analog Output, 6-Point, Current Loop (4-20 mA) Module (Isolated)

Parameter	Specification
Number of Points	6 galvanically isolated channels
Output Current Range	0 to 21.0 mA
Current Resolution	13 bits across 21 mA (2.7 μ A)
Open Circuit Detection	None
Output Overvoltage Protection	24 VAC/VDC continuous at room temperature
Open Short Circuit Protection	Electronically current limited to 21 mA or less
Drive Capability	20.0 mA max. into loads of 500 Ω or less. Loads of 1000 Ω or less may be achieved with alternate field terminations.
Calibrated Accuracy @ 25°C	Better than 0.1% of range from 4.0 mA to 21.0 mA
RFI Immunity	Error of less than 2.0% of range at 10 V/m, 27 to 1000 MHz
Module Update Rate for All Channels	25 ms
Output Settling Time	Less than 2 ms to 95% of final value with resistive loads
Output Offset Drift with Temperature	1 μ A /°C typical
Output Gain Drift with Temperature	60 ppm/°C typical
Power Dissipation	6.7 W max
Backplane Current	See Module Power Consumption Data, page 46.
Isolation Voltage Channel to channel User to system	100% tested at 2546 VDC for 1 second 100% tested at 2546 VDC for 1 second
Connection Terminal Blocks	TC-TBNH, 20-position terminal block

TC-OAV061, TK-OAV061**Table 6-8** Analog Output, 6-point, Voltage (10V) Module (Isolated)

Parameter	Specification
Number of Points	6 galvanically isolated channels
Output Voltage Range	± 10.50 VDC into loads of 1 K Ω or larger
Voltage Resolution	14 bits across 21 V (1.4 millivolts) (13 bits across 10.5 V plus sign bit)
Output Impedance	Less than 3 Ω
Open Circuit Detection	None
Output Overvoltage Protection	24 VAC/VDC continuous at room temperature
Open Short Circuit Protection	Continuous with electronic current limiting
Calibrated Accuracy @ 25°C	Better than 0.1% of range
RFI Immunity	Error of less than 2.0% of range at 10 V/m, 27 to 1000 MHz
Module Update Rate for All Channels	25 ms
Output Settling Time	Less than 2 ms to 95% of final value with resistive loads
Output Offset Drift with Temperature	60 μ V/°C typical
Output Gain Drift with Temperature	50 ppm/°C typical
Power Dissipation	4.9 W max
Backplane Current	See Module Power Consumption Data, page 46.
Isolation Voltage Channel to channel User to system	100% tested at 2546 VDC for 1s 100% tested at 2546 VDC for 1s
Connection Terminal Blocks	TC-TBNH, 20-position terminal block

TC-IXL061, TK-IXL061**Thermocouple Input, 6-Point Module**

This module has been replaced by TC/TK- **IXL062**. When replacing an Tx-IXL061 with the Tx-IXL062 module, it's necessary to rewire the terminal block. When the RTP is used, a new pre-wire cable is required.

Parameter	Specification
Number of Points	6 channels plus 1 cold junction channel
Nominal Input Voltage Ranges	-12 mV to +78 mV -12 mV to +30 mV (high resolution range)
Supported Thermocouple Types	B, E, J, K, R, S, T, N, C
Resolution	16 bits (1.4 μ V typical) 0.70 μ V on high resolution range
Accuracy (millivolts) @25°C (-12 mV to +78 mV Range) (-12 mV to +30 mV Range)	0.1% FSR \pm 90 μ V 0.1% FSR \pm 42 μ V
Accuracy (Cold Junction Sensor) Local CJ Sensor Error Remote CJ Sensor Error	From \pm 0.3 to \pm 3.0°C, depending on channel \pm 0.3°C
Common Mode Rejection	120 dB @ 60 Hz, 100 dB @ 50 Hz
Module Update Rate for All Channels	50 milliseconds
Settling Time to 5% of Full Scale	Less than 80 milliseconds
Open Circuit Detection Open TC Detection Time	Upscale reading 5 seconds typical
Channel Bandwidth	0 to 15 Hz (-3 db)
Normal Mode Noise Rejection	60 dB @ 60 Hz
RFI Immunity	Error of less than 2.0% of range at 10 V/m, 27 to 1000 MHz
Oversoltage Capability	120 VAC/VDC continuous at 25°C
Input Offset Drift with Temperature	0.5 μ V/°C typical
Gain Drift with Temperature	65 ppm/°C typical
Power Dissipation	4.3 W max
Backplane Current	See Module Power Consumption Data, page 46.
Spare CJR Thermistor Model Number	TC-CJRT01 (part no. 51109433-100)
Isolation Voltage Channel to channel User to system	100% tested at 2546 VDC for 1s 100% tested at 2546 VDC for 1s
Connection Terminal Blocks	TC-TBNH, 20-position terminal block
To maintain a \pm 3 °C (\pm 5 °F) Reference Junction Compensation for the thermocouple, the chassis containing the module should be mounted in a NEMA 4 or NEMA 12 enclosure that is approximately 24 in. (610mm) wide, 20 in. (508mm) high, and 8 in. (203mm) deep.	

TC-IXL062, TK-IXL062**Table 6-9** Thermocouple Input, 6-Point Module

Parameter	Specification
Number of Points	6 channels plus 2 cold junction channels
Nominal Input Voltage Ranges	-12 mV to +78 mV -12 mV to +30 mV (high resolution range)
Supported Thermocouple Types	B, E, J, K, R, S, T, N, C, D, L, D. See note-1
Resolution	16 bits (1.4 μ V typical) 0.70 μ V on high resolution range
Accuracy (millivolts) @25°C (-12 mV to +78 mV Range) (-12 mV to +30 mV Range)	0.1% FSR \pm 90 μ V 0.1% FSR \pm 42 μ V
Accuracy (Cold Junction Sensor) Local CJ Sensor (TB) and Remote CJ Sensor (RTP) Error	\pm 0.3°C
Common Mode Rejection	160db min. tested @ 600VAC, 60Hz, 100 Ω imbalance.
Module Update Rate for All Channels	50 milliseconds
Settling Time to 5% of Full Scale	Less than 80 milliseconds
Open Circuit Detection Open TC Detection Time	Upscale reading 2 seconds typical
Channel Bandwidth	0 to 15 Hz (-3 db)
Normal Mode Noise Rejection	60 dB @ 60 Hz
RFI Immunity	TBD
Overvoltage Capability	120 VAC/VDC continuous at 25°C
Input Offset Drift with Temperature	0.5 μ V/°C typical
Gain Drift with Temperature	25ppm/°C (2.3uV for -12mV to +78mV range, 1.1uV for -12mV to +30mV range)
Power Dissipation	4.3 W max
Backplane Current	See Module Power Consumption Data, page 46.
Spare CJR Thermistor Model Number	TC-CJRT02 (Note: this module uses 2 CJR's)
Isolation Voltage Channel to channel User to system	250V, 100% tested at 1900V for 2S
Connection Terminal Blocks	TC-TBNH, 20-position terminal block
Input Impedance	>10Meg Ω
Note-1 D & L TC types are not supported for releases prior to Experion PKS R210 patch 10.	

TC-IXR061, TK-IXR061**Table 6-10** RTD Input, 6-Point Module (Isolated)

Parameter	Specification
Number of Points	6 galvanically isolated channels
Signal Input Ranges	1-487 Ω , 2-1000 Ω , 4-2000 Ω , 8-4020 Ω
Sensors Supported	Resistance 1-487 Ω 100, 200, 500,1000 Ω Platinum, $\alpha = 0.00385$ 100, 200, 500,1000 Ω Platinum, $\alpha = 0.003916$ 120 Ω Nickel, $\alpha = 0.00672$ 100, 120, 200, 500 Ω Nickel, $\alpha = 0.00618$ 10 Ω Copper
Resolution 487 Ω , 100 Ω Pt, 100 Ω Ni, 10 Ω Cu 1000 Ω , 200 Ω Pt, 200 Ω Ni 2000 Ω , 500 Ω Pt, 500 Ω Ni 4020 Ω , 1000 Ω Pt	16 bits across each input range 7.7 milliohm/bit 15 milliohm/bit 30 milliohm/bit 60 milliohm/bit
Accuracy	0.1% FS @ 25°C
Module Update Rate for All Channels	50 milliseconds
Settling Time to 5% of Full Scale	Less than 80 milliseconds
Open Wire Detection Open Wire Detection Time	Out of Range reading reported Less than 5 seconds
Common Mode Rejection	120 dB @ 60 Hz, 100 dB @ 50 Hz
Channel Bandwidth	DC to 15 Hz (-3 db)
Normal Mode Noise Rejection	60 dB @ 60 Hz
RFI Immunity	Error of less than 2.0% of FS at 10 V/m, 27 to 1000 MHz
Input Offset Drift with Temperature	10 milliohms/°C typical
Gain Drift with Temperature	50 ppm/°C typical
Power Dissipation	4.3 W max
Backplane Current	See Module Power Consumption Data, page 46.
Isolation Voltage Channel to channel User to system	100% tested at 2546 VDC for 1s 100% tested at 2546 VDC for 1s
Connection Terminal Blocks	TC-TBNH, 20-position terminal block

TC-IAH161, TK-IAH161**Table 6-11** High Level Analog, 16-Input, Voltage and Current (10 V & 4-20 mA) Module

Parameter	Specification
Number of Points	16 channels
Input Voltage Range (Voltage) Input Current Range (Current)	± 10.25 volts, 0 to 10.25 volts, 0 to 5.125 volts 0 to 20.5 mA (internal 250 Ω resistor)
Voltage Resolution ± 10.5 volt range 0 to 10.5 volt range 0 to 5 volt range Current Resolution	16 bits across each range shown below 320 μ V 160 μ V 80 μ V 320 η A
Module Publish Rate	250 msec
Input Impedance (Voltage) (Current)	Greater than 1.0 meg Ω 249 ohms Ω nominal
Open Circuit Detection Typical OC Detection Time	Voltage Even channels - Positive Full scale reading Odd channels – Negative Full scale reading Current – Negative Full scale reading less than 5 seconds
Normal Mode Noise Rejection Common Mode Rejection	Greater than 33 dB @ 50 Hz Greater than 60 dB @ 60 Hz 100 dB @ 50/60 Hz
Channel Bandwidth	20 Hz(-3dB)
Calibrated Accuracy @ 25°C	Better than 0.05% of range (Voltage) Better than 0.15% of range including sense resistor (Current)
RFI Immunity	Error of less than 2.0% of range at 10 V/m, 27 to 1000 MHz
Overvoltage Capability	Continuous at room temperature (both) 30 VDC (Voltage) 8 VDC (Current)
Input Offset Drift with Temperature	<90 μ V/°C(Voltage) <360 η A/°C typical (Current)
Gain Drift with Temperature	15 ppm/°C (Voltage); 20 ppm/°C (Current)
Module Error Over Full Temp. Range	0.1% of range(Voltage) 0.3% of range(current)
Power Dissipation	4.1 W max
Backplane Current	See Module Power Consumption Data, page 46.
Isolation Voltage User to system	100% Tested at 2550VDC for 1s
Connection Terminal Blocks	TC-TBCH, 36-position terminal block

TC-OAV081, TK-OAV081**Table 6-12** Analog Output, 8-Point, Current/Voltage Module

Parameter	Specification
Number of Points	8 channels
Voltage Output Range Current Output Range	± 10.4 V 0 to 21 mA
Voltage Resolution Current Resolution	320 μ V per count 650 nA per count
Output Overvoltage Protection	24 VAC/VDC continuous at room temperature
Open Short Circuit Protection	Electronically current limited to 21 mA or less
Drive Capability	>2000 Ω (Voltage) 0-750 Ω (Current)
Calibrated Accuracy @ 25°C	Better than 0.05% of range From 4 to 21 ma (Current) From -10.4V to +10.4V(Voltage)
RFI Immunity	Error of less than 2.0% of range at 10 V/m, 27 to 1000 MHz
Module Update Rate for All Channels	25 ms
Output Settling Time	Less than 2 ms to 95% of final value with resistive loads
Output Offset Drift with Temperature	50 μ V/°C typical (voltage) 100 nA/°C typical (current)
Output Gain Drift with Temperature	25 ppm/°C maximum (voltage) 50 ppm/°C maximum (current)
Module Error Over Full Temp. Range	0.15% of range(Voltage) 0.3% of range (Current)
Isolation Voltage User to system	100% Tested at 2550VDC for 1s
Power Dissipation	6.9 W max
Backplane Current	See Module Power Consumption Data, page 46.
Connection Terminal Blocks	TC-TBNH, 20-position terminal block

TC- ORC081, TK- ORC081**Table 6-13** Relay Discrete Output Module

Parameter	Specification												
Number of Points	8 N.O. and 8 N.C. (2 points/common) contacts												
Output Voltage Range	10-265 VRMS, 47-63 Hz / 5-150 VDC												
Output Voltage Range (load dependent)	5-30V dc @ 2.0A resistive 48V dc @ 0.5A resistive 125V dc @ 0.25A resistive 125V ac @ 2.0A resistive 240V ac @ 2.0A resistive												
Output Current Rating (at rated power)	<table border="0"> <tr> <td><u>Resistive</u></td> <td>Inductive</td> </tr> <tr> <td>2A @ 5-30V dc</td> <td>2.0A steady state @ 5-30V dc</td> </tr> <tr> <td>0.5A @ 48V dc</td> <td>0.5A steady state @ 48V dc</td> </tr> <tr> <td>0.25A @ 125V dc</td> <td>0.25A steady state @ 125V dc</td> </tr> <tr> <td>2A @ 125V ac</td> <td>2.0A steady state, 15A make @ 125V ac</td> </tr> <tr> <td>2A @ 240V ac</td> <td>2.0A steady state, 15A make @ 240V ac</td> </tr> </table>	<u>Resistive</u>	Inductive	2A @ 5-30V dc	2.0A steady state @ 5-30V dc	0.5A @ 48V dc	0.5A steady state @ 48V dc	0.25A @ 125V dc	0.25A steady state @ 125V dc	2A @ 125V ac	2.0A steady state, 15A make @ 125V ac	2A @ 240V ac	2.0A steady state, 15A make @ 240V ac
<u>Resistive</u>	Inductive												
2A @ 5-30V dc	2.0A steady state @ 5-30V dc												
0.5A @ 48V dc	0.5A steady state @ 48V dc												
0.25A @ 125V dc	0.25A steady state @ 125V dc												
2A @ 125V ac	2.0A steady state, 15A make @ 125V ac												
2A @ 240V ac	2.0A steady state, 15A make @ 240V ac												
Power Rating (Steady State)	250 W maximum for 125 VAC resistive output 480 W maximum for 240 VAC resistive output 60 W maximum for 30 VDC resistive output 24 W maximum for 48 VDC resistive output 31 W maximum for 125 VDC resistive output 250 VA maximum for 125 VAC inductive output 480 VA maximum for 240 VAC inductive output 60 VA maximum for 30 VDC inductive output 24 VA maximum for 48 VDC inductive output 31 VA maximum for 125 VDC inductive output												
Minimum Load Current	10 mA per output												
Initial Contact Resistance	30 meg-ohms												
Switching Frequency	1 operation/3 second (0.3 Hz at rated load) maximum												
Bounce Time	1.2 ms (mean)												
Minimum Contact Load	100 μ A												
Expected Contact Life	300K cycles resistive / 100K cycles inductive												
Maximum Off-State Leakage Current	0 mA												
Output delay Time Off to On On to Off	13 ms max 13 ms max												
Power Dissipation	3.1 W @ 60 °C max												
Thermal Dissipation	10.57 BTU/hr (41.9 kcal/hr)												
Backplane Current	See Module Power Consumption Data, page 46.												
Configurable Fault States/Point	Hold Last State, ON or OFF (OFF is the default)												
Configurable States in Program Mode/Point	Hold Last State, ON or OFF (OFF is the default)												
Fusing	Not protected – Fused RTP recommended to protect outputs.												
Isolation Voltage Channel to channel User to system	100% tested at 2546 VDC for 1s (256V ac maximum continuous voltage between channels) 100% tested at 2546 VDC for 1s												
UL Ratings	C300, R150 Pilot Duty												
RTB Screw Torque (cage clamp)	4.4 inch-pounds (0.4Nm) maximum												
Connection Terminal Blocks	TC-TBCH, 36-position terminal block												

TC- ORC081, TK- ORC081**Table 6-14** Relay Discrete Output Module

Parameter	Specification												
Number of Outputs	16 N.O. (Contacts individually isolated)												
Maximum Power Dissipation	4.5W @ 60 DEGC												
Thermal Dissipation	15.35 BTU/hr												
Output Voltage Range	10-265V 47-63Hz/5-150V dc												
Output Voltage Range (load dependent)	5-30V dc @ 2.0A resistive 48V dc @ 0.5A resistive 125V dc @ 0.25A resistive 125V ac @ 2.0A resistive 240V ac @ 2.0A resistive												
UL Ratings	C300, R150 Pilot Duty												
Minimum Load Current	10mA per point												
Initial Contact Resistance	30 meg-Ohms												
Switching Frequency	1 operation/3s (0.3Hz at rated load) maximum												
Bounce Time	1.2ms (mean)												
Expected Contact Life	300k cycles resistive/100k cycles inductive												
Maximum Off-State Leakage Current	1.5mA per point												
Output Delay Time OFF to ON ON to OFF	10ms maximum 10ms maximum												
Output Current Rating (at rated power)	<table border="0"> <thead> <tr> <th><u>Resistive</u></th> <th><u>Inductive</u></th> </tr> </thead> <tbody> <tr> <td>2A @ 5-30V dc</td> <td>2.0A steady state @ 5-30V dc</td> </tr> <tr> <td>0.5A @ 48V dc</td> <td>0.5A steady state @ 48V dc</td> </tr> <tr> <td>0.25A @ 125V dc</td> <td>0.25A steady state @ 125V dc</td> </tr> <tr> <td>2A @ 125V ac</td> <td>2.0A steady state, 15A make @ 125V ac</td> </tr> <tr> <td>2A @ 240V ac</td> <td>2.0A steady state, 15A make @ 240V ac</td> </tr> </tbody> </table>	<u>Resistive</u>	<u>Inductive</u>	2A @ 5-30V dc	2.0A steady state @ 5-30V dc	0.5A @ 48V dc	0.5A steady state @ 48V dc	0.25A @ 125V dc	0.25A steady state @ 125V dc	2A @ 125V ac	2.0A steady state, 15A make @ 125V ac	2A @ 240V ac	2.0A steady state, 15A make @ 240V ac
<u>Resistive</u>	<u>Inductive</u>												
2A @ 5-30V dc	2.0A steady state @ 5-30V dc												
0.5A @ 48V dc	0.5A steady state @ 48V dc												
0.25A @ 125V dc	0.25A steady state @ 125V dc												
2A @ 125V ac	2.0A steady state, 15A make @ 125V ac												
2A @ 240V ac	2.0A steady state, 15A make @ 240V ac												
Power Rating (steady state)	250W maximum for 125V ac resistive output 480W maximum for 240V ac resistive output 60W maximum for 30V dc resistive output 24W maximum for 48V dc resistive output 31W maximum for 125V dc resistive output 250VA maximum for 125V ac inductive output 480VA maximum for 240V ac inductive output 60VA maximum for 30V dc inductive output 24VA maximum for 48V dc inductive output 31VA maximum for 125V dc inductive output												
Configurable Fault States/Point	Hold Last State, ON or OFF (OFF is the default)												
Configurable States in Program Mode per Point	Hold Last State, ON or OFF (OFF is the default)												
Fusing	Not protected – Fused RTP can be used to protect outputs.												
Isolation Voltage User to system	250V maximum continuous 100% tested at 2546V dc for 1s												
Backplane Current	See Module Power Consumption Data, page 46.												
Connection Terminal Block	TC-TBCH, 36 Position Terminal Block												

TC-IDK161, TK-IDK161**Table 6-15** 120 VAC, 16-Point, Isolated Discrete Input Module

Parameter	Specification
Number of Points	16 (individually isolated)
On-State Voltage Range	79-132 VAC, 47-63 Hz
Input Compatibility	IEC Type 1+
Short/Inrush Current	250 mA peak (decaying to <37% in 22 ms, without activation)
Nominal Input Voltage	120 VAC
Off-State Voltage (Maximum)	20 V
On-State Current (Minimum)	5 mA @ 79 V, 47-63 Hz 15 mA @ 132 V, 47-63 Hz
Off-State Current (Maximum)	2.5 mA
Input Impedance (Maximum)	11 K Ω @ 60 Hz
Input Delay Time Off to On Hardware Delay On to Off Hardware Delay	1 ms and 2 ms (programmable) 10 ms maximum plus filter time 9 ms and 18 ms (programmable) 8 ms maximum plus filter time
Power Dissipation	4.9 W
Backplane Current	See Module Power Consumption Data, page 46.
Isolation Voltage Channel to channel User to system	100% tested at 2546 VDC for 1s 100% tested at 2546 VDC for 1s
Connection Terminal Blocks	TC-TBCH, 36-position terminal block

TC-IDW161, TK-IDW161**Table 6-16** 220 VAC, 16-Point, Isolated Discrete Input Module

Parameter	Specification
Number of Points	16 (1 point/common)
On-State Voltage Range	159-265 VAC, 47-63 Hz @ 30°C All Channels 159-265 VAC, 47-63 Hz @ 40°C 8 points 159-253 VAC, 47-63 Hz @ 45°C All Channels 159-242 VAC, 47-63 Hz @ 60°C All Channels
Input Compatibility	IEC Type 1+
Short/Inrush Current	250 mA peak (decaying to <37% in 22 ms, without activation)
Nominal Input Current	Approx. 10 mA @ 220 VAC 60 Hz
Nominal Input Voltage	230 VAC
Off-State Voltage (Maximum)	40 V
On-State Current (Minimum)	5 mA @ 159 V, 60 Hz
Off-State Current (Maximum)	2.5 mA
Input Impedance (Maximum)	24 K Ω @ 60 Hz
Input Delay Time Off to On Hardware Delay On to Off Hardware Delay	1 ms and 2 ms (programmable) 10 ms maximum plus filter time 9 ms and 18 ms (programmable) 8 ms maximum plus filter time
Power Dissipation	7.9 watts
Backplane Current	See Module Power Consumption Data, page 46.
Isolation Voltage Channel to channel User to system	100% tested at 2546 VDC for 1s 100% tested at 2546 VDC for 1s
Connection Terminal Blocks	TC-TBCH, 36-position terminal block

TC-IDX081, TK-IDX081**Table 6-17** 120 VAC, 8-Point, Diagnostic Discrete Input Module

Parameter	Specification
Number of Points	8 (4 points/common)
On-State Voltage Range	79-132 VAC, 47-63 Hz
Input Compatibility	IEC Type 1+
Diagnostic Functions Open Wire Loss of Power	Current Leak, 1.5 mA minimum Transition range 46 to 85 VAC
To Determine Leakage Resistor (P/S = Field side Power Supply)	$R_{leak} \text{ Maximum} = (P/S \text{ Voltage} - 19 \text{ VAC}) / 1.5 \text{ mA}$ $R_{leak} \text{ Minimum} = (P/S \text{ Voltage} - 20 \text{ VAC}) / 2.5 \text{ mA}$
Leakage Resistor Values P/S Voltage 100Vac +/-10% 110Vac +/-10% 115Vac +/-10% 120Vac +/-15%	R_{leak} , ½ W, 5% 43KΩ, ½ W, 5% 47KΩ, ½ W, 5% 47KΩ, ½ W, 5% 51KΩ, ½ W, 5%
Short/Inrush Current	250 mA peak (decaying to <37% in 22 ms, without activation)
Nominal Input Current	120 VAC: 11 mA @ 50 Hz, 13 mA @ 60 Hz
Nominal Input Voltage	120 VAC
Off-State Voltage (Maximum)	20 V
On-State Current (Minimum)	5 mA @ 74 V, 47-63 Hz
Off-State Current (Maximum)	2.5 mA
Input Impedance (Maximum)	12K Ω @ 60 Hz
Input Delay Time Off to On Hardware Delay On to Off Hardware Delay	1 ms and 2 ms (programmable) 10 ms maximum plus filter time 9 ms and 18 ms (programmable) 8 ms maximum plus filter time
Power Dissipation	4.5 W
Backplane Current	See Module Power Consumption Data, page 46.
Isolation Voltage Channel to channel User to system	100% tested at 2546 VDC for 1s 100% tested at 2546 VDC for 1s
Connection Terminal Blocks	TC-TBNH, 20-position terminal block

TC-IDA161, TK-IDA161**Table 6-18** 120 VAC, 16-Point Discrete Input Module

Parameter	Specification
Number of Inputs	16 (8 pts/common)
On-stage Voltage Range	79-132 VAC, 47-63 Hz with zero tolerance (79-132 VAC, 50-60 Hz with tolerance for 1131-2 & IEC1+)
Nominal Input Voltage	120 VAC
On-State Current (Minimum)	5 mA @ 79 VAC, 47-63 Hz
Off-State Voltage (Maximum)	20 VAC
Off-State Current (Maximum)	2.5 mA
Input Impedance (Maximum)	11 k Ω @ 60 Hz
Input Delay Time Off to on Hardware delay On to off Hardware delay	Programmable: 1 ms & 2 ms 10 ms maximum plus filter time Programmable: 9 ms & 18 ms 8 ms maximum plus filter time
Power Dissipation	6.0 watts max
Short/Inrush Current	250 mA peak (decaying to <37% in 22 ms, without activation)
Nominal Input Current	120 VAC: 12.5 mA @ 50 Hz, 12.5 mA @ 60 Hz
Input Compatibility	IEC Type 1+
Backplane Current	See Module Power Consumption Data, page 46.
Isolation Voltage Channel to channel User to system	100% tested at 2546 VDC for 1s 100% tested at 2546 VDC for 1s
Connection Terminal Blocks	TC-TBNH, 20-position terminal block

TC-IDB321, TK-IDB321**Table 6-19** 120 VAC, 32-Point Discrete Input Module

Parameter	Specification
Number of Inputs	32 (16 pts/common)
On-stage Voltage Range	74-132 VAC, 47-63 Hz
Nominal Input Voltage	120 VAC
On-State Current (Minimum)	5 mA @ 74 VAC minimum 15mA @ 132 VAC maximum
Off-State Voltage (Maximum)	20 VAC
Off-State Current (Maximum)	2.5 mA
Input Impedance (Maximum)	14.0 k Ω @ 60 Hz
Input Delay Time Off to on Hardware delay On to off Hardware delay	Hardware delay (1.5ms nominal/10ms max.)+ input filter time (User selectable time: 1ms or 2ms) Hardware delay (1ms nominal /8ms max.) Input Filter Time (User selectable time: 9ms or 18ms)
Power Dissipation	6.1 watts @ 60C max

Short/Inrush Current	390 mA
Backplane Current	165mA@5.1VDC & 2.0mA @ 24VDC
Isolation Voltage Group to group User to system	250V continuous 250V continuous
Connection Terminal Blocks	TC-TBNH, 36-position terminal block

TC-ODK161, TK-ODK161**Table 6-20** 120/220 VAC, 16-Point, Isolated Discrete Output Module

Parameter	Specification
Outputs per Module	16 (individually isolated)
Output Voltage Range	74-265 VAC, 47-63 Hz
Output Current Rating Per Point Per Module	2.0 A max @ 30°C & 2.0 A max @ 60°C 5.0 A max @ 30°C & 4.0 A max @ 60°C
Surge Current	20 A for 43 ms each, repeatable every 2 sec @ 60°C
On-State Current (Minimum)	10 mA per output
On-State Voltage Drop (Maximum)	1.5 Vrms @ 2.0 A, 6.0 Vrms @ I < 50 mA
Maximum Inhibit Voltage (zero crossing)	60 V peak
Off-State Leakage Current (Maximum)	3 mA per point
Output Signal Delay Off to On / On to Off	9.3 ms @ 60 Hz; 11 ms @ 50 Hz
Power Dissipation	9.6 W max
Backplane Current	See Module Power Consumption Data, page 46.
Isolation Voltage Channel to channel User to system	100% tested at 2546 VDC for 1s 100% tested at 2546 VDC for 1s
Connection Terminal Blocks	TC-TBCH, 36-position terminal block
120 VAC and 220 VAC connections may be freely mixed on this module. It is not limited to all 120 or all 220 connections.	

TC-ODX081, TK-ODX081**Table 6-21** 120 VAC, 8-Point, Diagnostic Discrete Output Module

Parameter	Specification
Outputs per Module	8 (4 points/common)
On-state Voltage Range Change of State	74-132 VAC, 47-63 Hz Software configurable
Output Current Rating Per Point Per Module	1 A max @ 30°C & 0.5 A max @ 60°C 8 A max @ 30°C & 4 A max @ 60°C
Surge Current	8 A for 50 ms each, repeatable every 2 sec @ 30°C 5 A for 50 ms each, repeatable every 2 sec @ 60°C
On-State Current (Minimum)	10 mA per output
On-State Voltage Drop (Maximum)	2.5 V peak @ 0.5 A, 3.0 V peak @ 1 A
Maximum Inhibit Voltage (zero crossing)	25 V peak
Diagnostic Functions Overload/Short Trip No Load Output Verification Pulse Test	12 A for 500 μ s minimum 74-132 Vac @ 12 μ A on detection minimum 74-132 Vac on detection @ 12 μ A minimum 100 μ s increment user selectable width and 100 μ s increment user selectable time delay from zero cross
Off-State Leakage Current (Maximum)	3 mA per point
Output Signal Delay (max) Off to On On to Off	9.3 ms @ 60 Hz; 11 ms @ 50 Hz 9.3 ms @ 60 Hz; 11 ms @ 50 Hz
Power Dissipation	13.8 watts
Backplane Current	See Module Power Consumption Data, page 46.
Isolation Voltage Channel to channel User to system	100% tested at 2546 VDC for 1s 100% tested at 2546 VDC for 1s
Connection Terminal Blocks	TC-TBNH, 20-position terminal block

TC-ODA161, TK-ODA161**Table 6-22** 120/220 VAC, 16-Point Discrete Output Module

Parameter	Specification
Number of Outputs	16 (4 points/common)
Output Voltage Range	74-265 VAC, 47-63 Hz
Output Current Rating Per Point Per Module	2 A maximum @ 30°C & 1 A maximum @ 60°C 5 A maximum @ 30°C & 4 A maximum @ 60°C
Surge Current	20 A for 43 ms each, repeatable every 2 secs @ 60°C
Minimum Load Current	10 mA per output
Maximum On-State Voltage Drop	1.5V peak @ 2 A & 6 V peak @ load current < 50 mA
Maximum Off-State Leakage Current	3 mA per point
Output Delay Time Off to on On to off	1ms plus 1/2 cycle maximum 1ms plus 1/2 cycle maximum
Configurable Fault States per Point	Hold Last State, ON or OFF
Configurable States in Program Mode per Point	Hold Last State, ON or OFF
Backplane Current	See Module Power Consumption Data, page 46.
Power Dissipation	6.5 watts
Isolation Voltage Channel to channel User to system	100% tested at 2546 VDC for 1s 100% tested at 2546 VDC for 1s
Maximum Inhibit Voltage	Zero crossing 60 V peak
Connection Terminal Blocks	TC-TBNH, 20-position terminal block

TC-IDJ161, TK-IDJ161**Table 6-23** 24 VDC, 16-Point, Isolated Discrete Input Module

Parameter	Specification
Number of Points	16 (individually isolated)
On-State Voltage Range Nominal Input Voltage	10-30 VDC 24 VDC
Input Compatibility	IEC Type 1+
Short/Inrush Current	250 mA peak (decaying to <37% in 22 ms, without activation)
Off-State Voltage (Maximum)	5 VDC
On-State Current (Minimum)	2.0 mA @ 10 VDC
Off-State Current (Maximum)	1.5 mA
Input Impedance (Maximum)	31 K Ω @ 60 Hz
Input Delay Time Off to on Hardware delay On to off Hardware delay	Programmable: 1 ms & 2 ms 1 ms maximum plus filter time Programmable: 1 ms, 2 ms, 9 ms & 18 ms 4 ms maximum plus filter time
Power Dissipation	5.0 W max
Backplane Current	See Module Power Consumption Data, page 46.
Isolation Voltage Channel to channel User to system	100% tested at 2546 VDC for 1s 100% tested at 2546 VDC for 1s
Connection Terminal Blocks	TC-TBCH, 36-position terminal block

TC-IDX161, TK-IDX161**Table 6-24** 10-30 VDC, 16-Point Diagnostic Discrete Input Module

Parameter	Specification
Number of Points	16 (4 points/common)
On-State Voltage Range Nominal Input Voltage	10-30 VDC 24 VDC
Input Compatibility	IEC Type 1+
Diagnostic Functions Open Wire Change of State	Current leakage off state 1.21 mA maximum Software configurable
To Determine Leakage Resistor (P/S = Field side Power Supply)	$R_{leak} \text{ Maximum} = (P/S \text{ Voltage} - 4.6 \text{ VDC}) / 1.21\text{mA}$ $R_{leak} \text{ Minimum} = (P/S \text{ Voltage} - 5 \text{ VDC}) / 1.5\text{mA}$
Leakage Resistor Value P/S Voltage 12Vdc +/-5% 24Vdc +/-5%	R_{leak} , ¼ W, 2% 5.23KΩ, ¼ W, 2% 14.3KΩ, ¼ W, 2%
Short/Inrush Current	250 mA peak (decaying to <37% in 22 ms, without activation)
Off-State Voltage (Maximum)	5 VDC
On-State Current (Minimum)	2.0 mA @ 10 VDC
Off-State Current (Maximum)	1.5 mA
Input Impedance (Maximum)	3.7 KΩ @ 10 VDC
Input Signal Delay Off to On On to Off	0, 1 or 2 ms (programmable) 0, 1, 9 or 18 ms (programmable)
Power Dissipation	5.8 W max
Backplane Current	See Module Power Consumption Data, page 46.
Isolation Voltage Channel to channel User to system	100% tested at 2546 VDC for 1s 100% tested at 2546 VDC for 1s
Connection Terminal Blocks	TC-TBCH, 36-position terminal block

TC-IDD321, TK-IDD321**Table 6-25** 24 VDC, 32-Point Discrete Input Module

Parameter	Specification
Number of Inputs	32 (16 points/common)
On-stage Voltage Range	10-31.2 VDC @ 60 °C all channels
Nominal Input Voltage	24 VDC
On-State Current (Minimum)	2 mA
Off-State Voltage (Maximum)	5 V
Off-State Current (Maximum)	1.5 mA
Isolation Voltage Channel to channel User to system	100% tested at 1500 VDC for 1 second 100% tested at 1500 VDC for 1 second
Input Delay Time Off to on Hardware delay On to off Hardware delay	Programmable filter: 0 ms, 1 ms, or 2 ms 1 ms maximum plus filter time Programmable filter: 0 ms, 1 ms, 2 ms, 9 ms, or 18 ms 1 ms maximum plus filter time
Power Dissipation	6.1 W max
Short/Inrush Current	250 mA peak (decaying to <37% in 22 ms, without activation)
Input Compatibility	IEC Type 1+
Backplane Current	See Module Power Consumption Data, page 46.
Connection Terminal Blocks	TC-TBCH, 36-position terminal block

TC-ODJ161, TK-ODJ161**Table 6-26** 24 VDC, 16-Point, Isolated Discrete Output Module

Parameter	Specification
Number of Points	16 (individually isolated)
Output Voltage Range	10-30 VDC
Output Current Rating Per Point Per Module	2.0 A max @ 30 °C & 1.0 A max @ 60 °C 8.0 A max @ 30 °C & 4.0 A max @ 60 °C
Surge Current	4 A for 10 ms each, repeatable every 2 sec
On-State Current (Minimum)	1.0 mA per output
On-State Voltage Drop (Maximum)	1.2 VDC @ 2.0 A
Off-State Leakage Current (Maximum)	0.5 mA per point
Output Signal Delay (Maximum) Off to On On to Off	1.0 ms max 2.0 ms max
Power Dissipation	4.7 W max
Backplane Current	See Module Power Consumption Data, page 46.
Isolation Voltage	1500 VAC (RMS) output to backplane
Connection Terminal Blocks	TC-TBCH, 36-position terminal block

TC-ODX161, TK-ODX161**Table 6-27** 10-30 VDC, 16-Point Diagnostic Discrete Output Module

Parameter	Specification
Number of Points	16 (8 points/common)
On-State Voltage Range	19.2-30 VDC
Output Current Rating Per Point Per Module	2.0 A max @ 30 °C & 1.0 A max @ 60 °C 8.0 A max @ 30 °C & 4.0 A max @ 60 °C
Surge Current	4 A for 10 ms each, repeatable every 1 sec
On-State Current (Minimum)	1.0 mA per output
On-State Voltage Drop (Maximum)	1.2 VDC @ 2.0 A
Diagnostic Functions Thermal Overload Short/Trip No Load Output Verification Pulse Test	6 A 350 ms minimum 8 A 180 ms minimum 10 A 120 ms min 5 VDC min @ 3 mA min 5 VDC min on detection 1 or 2 ms user selectable pulse width
Off-State Leakage Current (Maximum)	1.0 mA per point
Fault State	User definable On or Off
Output Signal Delay (Maximum) Off to On On to Off	1.0 ms max 5.0 ms max
Power Dissipation	5.1 W max
Backplane Current	See Module Power Consumption Data, page 46.
Isolation Voltage	1500 VAC (RMS) output to backplane and between commons
Connection Terminal Blocks	TC-TBCH, 36-position terminal block

TC-ODD321, TK-ODD321**Table 6-28** 24 VDC, 32-Point Discrete Output Module

Parameter	Specification
Number of Outputs	32 (16 points/common)
Output Voltage Range	10-31.2 VDC @ 50°C (Linear derating) 10-28 VDC @ 60°
Output Current Rating Per Point Per Module	0.5A maximum @ 50°C (Linear derating) 0.35A maximum @ 60°C 16A maximum @ 50°C (Linear derating) 10A maximum @ 60°C
Surge Current	1A for 10ms each, repeatable every 2s @ 60C
Flash On Time	100 µsec target, 150 µsec max
On-State Current Load (Minimum)	3.0 mA per output
On-State Voltage Drop (Maximum)	1 VDC @ rated current per point (3 VDC for IEC 1131-2)
Off-State Leakage Current (Maximum)	0.5 mA per point (1 mA per point IEC 1131-2 for 0.25 A output)
Configurable Fault States per Point	Hold Last State, ON or OFF (OFF is the default)
Configurable States in Program Mode per Point	Hold Last State, ON or OFF (OFF is the default)
Fusing	Not protected - Fused IFM is recommended to protect outputs
Reverse Polarity Protection	None - If module is wired incorrectly, outputs may be damaged.
Output Delay Time Off to on On to off	1.0 ms maximum 1.0 ms maximum
Power Dissipation	6.1 W
Backplane Current	See Module Power Consumption Data, page 46.
Isolation Voltage Group to group User to system	100% tested at 2546V dc for 1s (250V ac maximum continuous voltage between groups) 100% tested at 2546V dc for 1s
Connection Terminal Blocks	TC-TBCH, 36-position terminal block

TC-HAI081, TK-HAI081**Table 6-29** HART- High Level Analog, 8-Input, Voltage/Current, and HART Module

Parameter	Specification															
Number of Points/Channels	8 single ended input channels															
Available input ranges for channels configured for non-HART. Voltage and Current Ranges:	<table border="1"> <thead> <tr> <th>Actual Range:</th> <th>Configuration Selection:</th> <th>Resolution:</th> </tr> </thead> <tbody> <tr> <td>±10.25 volts</td> <td>±10 volts</td> <td>16 bits (313 µV/bit)</td> </tr> <tr> <td>0 to 10.25 volts</td> <td>0-10 volts</td> <td>16 bits (153 µV/bit)</td> </tr> <tr> <td>0 to 5.125 volts</td> <td>0-5 volts</td> <td>16 bits (78 µV/bit)</td> </tr> <tr> <td>0 to 20.58 mA</td> <td>4-20 mA</td> <td>16 bits (314 nA/bit)</td> </tr> </tbody> </table>	Actual Range:	Configuration Selection:	Resolution:	±10.25 volts	±10 volts	16 bits (313 µV/bit)	0 to 10.25 volts	0-10 volts	16 bits (153 µV/bit)	0 to 5.125 volts	0-5 volts	16 bits (78 µV/bit)	0 to 20.58 mA	4-20 mA	16 bits (314 nA/bit)
Actual Range:	Configuration Selection:	Resolution:														
±10.25 volts	±10 volts	16 bits (313 µV/bit)														
0 to 10.25 volts	0-10 volts	16 bits (153 µV/bit)														
0 to 5.125 volts	0-5 volts	16 bits (78 µV/bit)														
0 to 20.58 mA	4-20 mA	16 bits (314 nA/bit)														
Available input ranges for channels configured for HART. Input is automatically set to Current Range only.	<table border="1"> <thead> <tr> <th>Actual Range:</th> <th>Configuration Selection:</th> <th>Resolution:</th> </tr> </thead> <tbody> <tr> <td>0 to 20.58 mA</td> <td>4-20 mA</td> <td>16 bits (314 nA/bit)</td> </tr> </tbody> </table>	Actual Range:	Configuration Selection:	Resolution:	0 to 20.58 mA	4-20 mA	16 bits (314 nA/bit)									
Actual Range:	Configuration Selection:	Resolution:														
0 to 20.58 mA	4-20 mA	16 bits (314 nA/bit)														
HART Protocol Revision	Module is compliant with the specification for HART protocol Revision 5.7															
Module Publish Rate (for the analog 0-100% input value)	250 ms for all (8) channels															
Input Impedance:	(Voltage) Greater than 1.0 megΩ (Current) 249 ohms Ω nominal (internal sense resistor)															
Open Circuit Detection Typical OC Detection Time	(Voltage) – Positive Full scale reading (Current) – Negative Full scale reading Less than 5 seconds															
Normal Mode Noise Rejection: With 20 Hz. filter setting	Greater than 33 dB @ 50 Hz Greater than 60 dB @ 60 Hz															
Common Mode Rejection	Greater than 100 dB @ 50/60 Hz															
Channel Bandwidth	15.7 Hz. (-3dB) with 20 Hz. filter setting															
Calibrated Accuracy @ 25°C. Calibration interval –12 months typical.	Better than 0.05% of range (Voltage) Better than 0.15% of range (Current) including sense resistor.															
RFI Immunity	Error of less than 2.0% of range at 10 V/m, 27 to 1000 MHz															
Over voltage protection	Continuous at room temperature (both) 30 VDC (Voltage); 8 VDC (Current)															
Input Offset Drift with Temperature	<90 µV/°C (Voltage) typical. <TBD nA/°C (Current) typical.															
Gain Drift with Temperature	15 ppm/°C (Voltage) maximum 20 ppm/°C (Current) maximum															
Module Error Over Full Temp. Range	0.1% of range (Voltage) 0.3% of range (Current)															
Module Power Dissipation	4.1 W max															
Backplane Current	See Module Power Consumption Data, page 46.															
Isolation voltage, user to system	100% tested at 2550VDC for 1second															
Connection Terminal Blocks	TC-TBCH, 36-position terminal block															
HART wiring mode supported	Point-to-Point only. Multi-drop is not supported.															

TC-HAO081, TK-HAO081**Table 6-30** HART- Analog Output, 8-Point, Current/Voltage Module

Parameter	Specification															
Number of Points/Channels	8 output channels															
Available output ranges for channels configured for non-HART. Voltage and Current Ranges:	<table border="0"> <tr> <td>Actual</td> <td>Configuration</td> <td></td> </tr> <tr> <td><u>Range:</u></td> <td><u>Selection:</u></td> <td><u>Resolution:</u></td> </tr> <tr> <td>±10.4 volts</td> <td>±10 volts</td> <td>16 bits (323 μV/bit)</td> </tr> <tr> <td>0 to 10.25 volts</td> <td>0-10 volts</td> <td>15 bits (323 μV/bit)</td> </tr> <tr> <td>0 to 21 mA</td> <td>4-20 mA</td> <td>15 bits (656 nA/bit)</td> </tr> </table>	Actual	Configuration		<u>Range:</u>	<u>Selection:</u>	<u>Resolution:</u>	±10.4 volts	±10 volts	16 bits (323 μV/bit)	0 to 10.25 volts	0-10 volts	15 bits (323 μV/bit)	0 to 21 mA	4-20 mA	15 bits (656 nA/bit)
Actual	Configuration															
<u>Range:</u>	<u>Selection:</u>	<u>Resolution:</u>														
±10.4 volts	±10 volts	16 bits (323 μV/bit)														
0 to 10.25 volts	0-10 volts	15 bits (323 μV/bit)														
0 to 21 mA	4-20 mA	15 bits (656 nA/bit)														
Available output ranges for channels configured for HART. Output is automatically set to Current Range only.	<table border="0"> <tr> <td>Actual</td> <td>Configuration</td> <td></td> </tr> <tr> <td><u>Range:</u></td> <td><u>Selection:</u></td> <td><u>Resolution:</u></td> </tr> <tr> <td>0 to 21 mA</td> <td>4-20 mA</td> <td>15 bits (656 nA/bit)</td> </tr> </table>	Actual	Configuration		<u>Range:</u>	<u>Selection:</u>	<u>Resolution:</u>	0 to 21 mA	4-20 mA	15 bits (656 nA/bit)						
Actual	Configuration															
<u>Range:</u>	<u>Selection:</u>	<u>Resolution:</u>														
0 to 21 mA	4-20 mA	15 bits (656 nA/bit)														
HART Protocol Revision	Module is compliant with the specification for HART protocol Revision 5.7															
Module scan time (for the analog 0-100% output value)	10 ms for all (8) channels															
Over voltage Protection	24 VAC/VDC continuous at room temperature															
Short Circuit Protection Current Voltage	Electronically current limited to 21 mA or less. Electronically current limited to 35 mA or less.															
Drive Capability	>2000 . (Voltage) 50-750 . (Current) With short circuit protection for all (8) channels.															
Calibrated Accuracy @ 25°C Calibration interval –	Better than 0.1% of range (Voltage) Better than 0.15% of range (Current) 12 months typical															
RFI Immunity	Error of less than 2.0% of range at 10 V/m, 27 to 1000 MHz															
Output Settling Time Current Output, No HART Current Output, with HART Voltage Output	<23 ms to 95% of final value with resistive loads <35 ms to 95% of final value with resistive loads <8.5 ms to 95% of final value with resistive loads															
Offset Drift with Temperature	50 μV/°C (voltage) typical. 200 nA/°C (current) typical.															
Gain Drift with Temperature	20 ppm/°C (Voltage) maximum. 30 ppm/°C (Current) maximum.															
Module Error Over Full Temp. Range	0.3% of range (Voltage) 0.3% of range (Current)															
Isolation Voltage; User to system	100% tested at 2550VDC for 1second															
Module Power Dissipation	6.3 W max															
Backplane Current	See Module Power Consumption Data, page 46.															
Open loop current detection Typical OC Detection Time	Current outputs only. For proper detection, the channel output value must be greater than 0.1 mA. Less than 5 seconds															
Connection Terminal Blocks	TC-TBNH, 20-position terminal block															
HART wiring mode supported	Point-to-Point only. Multi-drop is not supported.															

6.6 Specifications – Specialty and Network Modules

TC-MDP081, TK-MDP081

Table 6-31 Pulse Input, 8 Channel Input/2 Channel Output

Parameter	Specification
Number of Inputs	8
Number of Outputs	2 (Note-1)
Input type	Floating; optically isolated
Output Type (2 output channels)	500mA; optically isolated
Frequency Range	0 - 100 kHz
Input Voltage	0 to 30 VDC selectable between: High Range: Counts based on input transitions at approx. 8.80 V Low Range: Counts based on input transitions at approx. 3.25V
Input Edge Selection	Each channel configured to sense an on-to-off transition based upon the leading edge or the trailing edge of the pulse
Input Voltage Hysteresis	High Range: 1.1V approx. 12.5% typical Low Range: 0.90V approx. 27% typical
Max. Input Current	12.5 mA
Typical Input Current	Low Range: 2mA High Range: 6mA
Input Channel Function Channels 0 through 5 Channels 6 and 7	Frequency and pulse length (pulse length measurement selectable between high, low or period) Accumulated value, frequency and target values
Counter Size	32 bit
Power Dissipation	7.0 watts max
Backplane Current	See Module Power Consumption Data, page 46.
Isolation Voltage	1500Vdc terminal block to backplane 1500Vdc channel-to-channel
Connection Terminal Blocks	TC-TBCH, 36-position terminal block
Note-1: The first six channels (0-5) do not have any outputs. The Off/On outputs are associated with the last two channels (6 and 7). User sets a target value and the output transitions from OFF to ON state when the input reaches the target.	

TC-MUX021, TK-MUX021

Table 6-32 Serial Interface, User-Configurable, 2 Channel

Parameter	Specification
Module Type	Double slot-width module
Maximum Number of SI Modules per Controller	3
Number of Communication Ports	Two (2), one per Field Termination Assembly (FTA)
Physical Interface Each Port	EIA RS-232D (DB-25) or EIA RS-422/485D (5-terminal compression connection), selectable per FTA
Maximum Communication Speed	19.2 kb/s per FTA
Supported FTA Models	MU-TSIM12, Modbus MU-TSIA12, Allen-Bradley DF1
Power Dissipation	10 watts
Backplane Current	See Module Power Consumption Data, page 46.
Vibration & Shock	10 to 50 Hz, 5 g, 30 g peak, 11 ms duration (operating)
Electro-static Discharge	2 kV to 15 kV anywhere on case, 10 kV on RS port lines
Noise	10 v/meter, 20 MHz to 100 MHz
Dielectric withstand	500 v to ground
Module Connection	TC-KSM003, Power Adapter Cable

(cont'd)

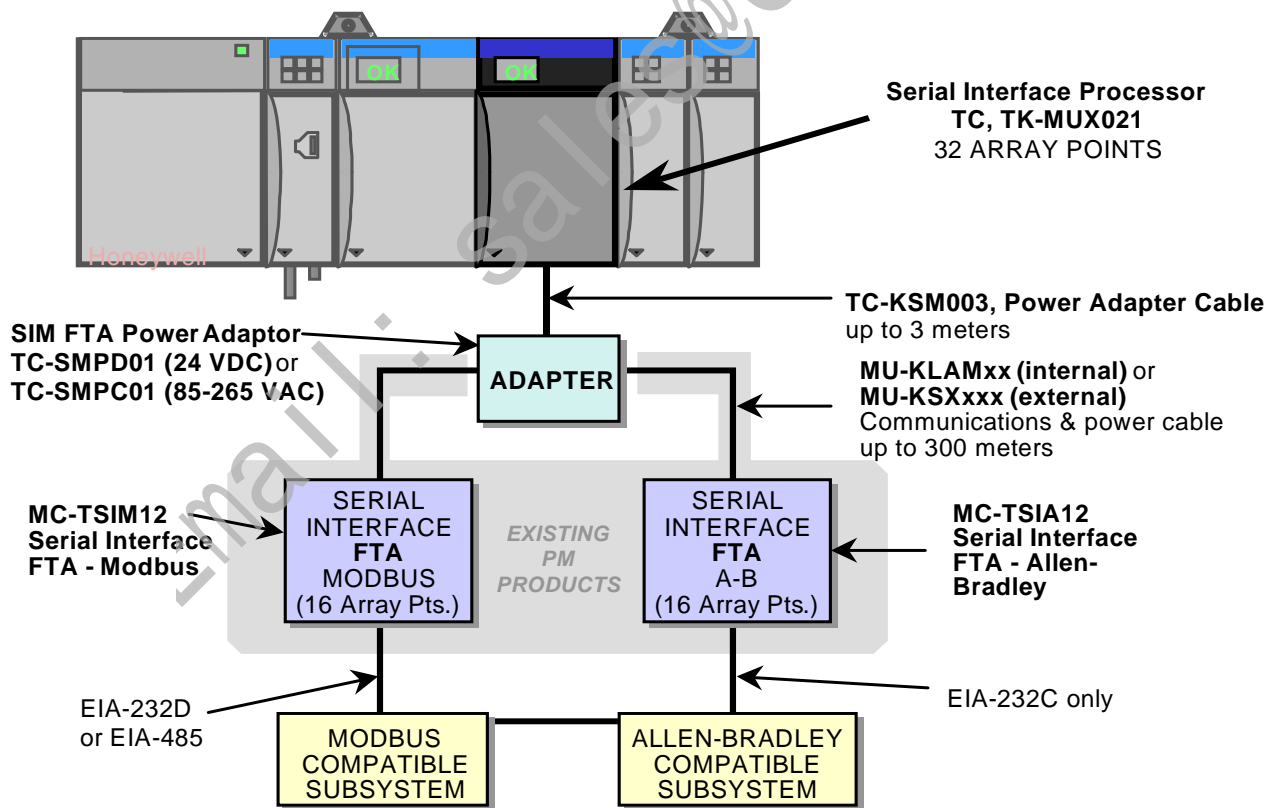

Figure 6-1 Serial Interface Processor Shown With Full Two-FTA Configuration

TC, TK-MUX021 - Serial Interface, User-Configurable, 2 Channel

The Experion **Serial Interface Module (SIM)**, TC-MUX021, enables bi-directional, serial-protocol communications between the Experion Control Processor and qualified third-party devices. The following models are required to configure a Serial Interface connection (note choices of Power Adapters, cables, and FTAs):

Model Number	Description
TC-MUX021	Serial Interface, 2 Channel
TC-KSM003	SIM-to-Power Adapter Cable (3 meters)
TC-SMPD01	SIM FTA Power Adapter 24 VDC <i>or</i>
TC-SMPC01	SIM FTA Power Adapter 85-265 VAC
MU-KLAMxx	Internal Cabinet Cable (Part # 51304465-xxx) <i>or</i>
MU-KSXxxx	External Cabinet Cable (Part # 51191673-xxx)
MC-TSIM12	Modbus FTA (Conformally Coated) <i>or</i>
MC-TSIA12	Allen-Bradley DF1 FTA (Conformally Coated) <i>or</i>
n/a	Custom protocol -- contact your Honeywell representative

The following are available options for MU-KLAMxx and MU-KSXxxx cables:

Model Number	Cable Description	Part Number
MU-KLAM01	Internal Cabinet Cable, 33 cm	51304465-100
MU-KLAM02	Internal Cabinet Cable, 66 cm	51304465-200
MU-KLAM03	Internal Cabinet Cable, 100 cm	51304465-300
MU-KLAM06	Internal Cabinet Cable, 200 cm	51304465-400
MU-KLAM09	Internal Cabinet Cable, 300 cm	51304465-500
MU-KSX030	External Cable, 30 m (100 ft.)	51191673-030
MU-KSX152	External Cable, 152 m (500 ft.)	51191673-152
MU-KSX305	External Cable, 305 m (1000 ft.)	51191673-305

The SIM uses Field Termination Assembly (FTA) and protocols developed for the APM/HPM product line (see next two pages). MU-TSIM12, Modbus FTA, supports standard Modbus RTU RS-232 or RS422/485 communications. MU-TSIA12, Allen-Bradley FTA, supports A-B DF1 serial protocol over Rs232 only.

Note that protocols developed under the PM/APM/HPM Serial Device Interface protocol or the Smart Transmitter Interface (STI) protocols are not supported.

MU-TSIM12 and MU-TSIA12 use industry standards to support many industrial devices. Contact your Honeywell representative for support of non-standard protocols.

MC-TSIM12**Table 6-33** Serial Interface FTA - Modbus

	Specification
Physical Interface	EIA-232D or EIA-485D
Devices Supported	Multivendor Qualified Modbus Compatible Devices
Distance--Power Adapter to FTA	Internal cable within cabinet or External cable 300 m (1000 ft.) maximum
Power Dissipation	1.4 watts max
Surge withstand capability	IEEE SWC 472-1974
ESD Protection	IEC 801.2
Number of Devices per SI IOM	2 FTAs per SI IOM Up to 15 devices per FTA
Data Quantity per IOM	16 Points per serial channel (organized as Arrays) Each point can access <i>one</i> of the following: <ul style="list-style-type: none"> • 512 Booleans into FLAGS • 16 Reals or 32 Integers into NUMERICS • 64 NUMERICS (Diagnostic Counter Data Only) • 1 STRING of 64 Characters • 2 STRINGS of 32 Characters • 4 STRINGS of 16 Characters • 8 STRINGS of 8 Characters
Serial Data Format	8 data bits with programmable 9th bit
EIA RS232-D Support Transmission Mode: Lines Supported: Distance--FTA to Device:	Serial asynchronous, bidirectional TXD, RXD, RTS, CTS, DSR, DTR, Logic GND, Protective GND 15 m (2500 pf cable capacity maximum)
EIA RS485D Support Transmission Mode: Lines Supported: Common Mode Operation: Number of drops: Distance--FTA to Device:	Serial asynchronous, bidirectional, half duplex only Two wire, differential pair: DATA+, DATA-, Protective GND (shield) 250 Vac rms (continuous) 15 drops maximum 1.2 km (4000 ft.) maximum
Modbus Interface Specification Protocol: Serial Line Mode: Selectable Baud Rates: Selectable Parity: Number of Stop Bits: Modem Control Support: Keep Alive Cell Write Message Response Timeout: Exception Errors Reported: Data Formats Supported: Intermessage stall time: Function Codes Supported:	(Default parameters are shown in bold .) Modbus, Remote Terminal Unit (RTU) RS232D or RS485D 1200, 2400, 4800, 9600, 19200 bps None, odd , or even 1 Selectable ON/ OFF Configurable address/ NONE Configurable timeout/ 1.5 seconds All Boolean, Real, ASCII Strings, Signed Integers 3.5 character time minimum 01, 02, 03, 04, 05, 06, 08, 16

MC-TSIA12

Table 6-34 Serial Interface FTA - Allen-Bradley

General	
Interface Type:	EIA-RS232-D
Number of Channels per IOP:	2
Distance -- Power Adapter to FTA:	300 m
Baud Rate:	19.2 k bps
Serial Data Format with parity bit:	8 data bits
Common Mode Operation:	250 V rms (continuous)
ESD Protection:	IEEE SWC 472-1974
Power Dissipation:	1.4 watts max
EIA-RS232-D Support	
Interface Type:	Serial asynchronous
Lines Supported:	TXD, RXD, Logic GND, Protective GND (Compatible with CCIT V.24; CCIT V.28)
Distance -- FTA to Device:	15 meters (cable cap. = 2500 pf max.)
SI A-B Specific Interface Specifications	
Protocol:	Full Duplex Allen-Bradley DF1 with embedded responses
Transmission Mode:	Character oriented
Serial Line Mode:	RS232D
Parity:	even
No. Stop Bits:	1
Modem Control Support:	Off
ACK Timeout:	3.2 sec.
FTA Message Response Timeout:	4.0 sec.
Data Formats Supported:	Booleans, Reals, Signed/Unsigned Integers, ASCII Strings
CIM Communication Options:	Pass-through diagnostic requests Ignore handshaking Accept duplicate message BCC error check
Allen-Bradley Family Types Supported:	
	PLC-2 PLC-3 (Native Mode and PLC-2 Mode) PLC-5, except PLC-5/250 (Native Mode and PLC-2 Mode)

Table 6-35 Allen-Bradley File Types

Array Point Types	PLC-5 File Types	PLC-3 Files Types
Flag	Output (O), Input (I), Status (S)	Output (O), Input (I), Status (S)
Flag	Bit (B)	Binary (B)
Numeric (16-bit Signed Integer)	Integer (N)	Integer (N)
Numeric (IEEE Single Precision)	Float (F) (IEEE Format)	
Numeric (16-bit Unsigned Integer)	Timer (T), Counter (C) (READ ONLY)	
String	ASCII (A)	ASCII (A)

7. Reference

7.1 Module Power Consumption Data

Data for individual module current consumption is provided below as a reference. For each chassis, the total current draw limit cannot be exceeded on each current bus.

Model Number	current draw @ 24vdc (amps)	current draw @ 5vdc (amps)	current draw @ 3.3vdc (amps)	current draw @ 1.2vdc (amps)
<i>Power Supply (limit)</i>	2.8	10.0	4.0	1.5
<i>All Chassis</i>	0.010		0.055	
<i>Controllers</i>				
TC-PNX021	0.005	1.500	1.000	0.007
TC/ TK-PRS021	0.005	1.600	1.300	0.007
<i>ControlNet</i>				
TC-CCN011	0.002	0.970		
TC-CCN012	0.002	0.970		
TC-CCR011	0.002	1.000		
TC/ TK-CCR012	0.002	1.000		
<i>Redundancy</i>				
TC-, TK-PRR021	0.090	1.000	0.750	0.007
<i>Battery Extension</i>				
TC, TK-PPD011	0.036	0.112		
<i>Analog</i>				
TC, TK-IAH061	0.100	0.250		0.005
TC, TK-OAH061	0.300	0.250		0.005
TC, TK-OAV061	0.175	0.250		0.005
TC, TK-IXL061	0.125	0.250		0.005
TC, TK-IXL062	TBD	TBD		TBD
TC, TK-IXR061	0.125	0.250		0.005
TC, TK-IAH161	0.060	0.200		0.005
TC, TK-HAI081	0.060	0.350		0.005
TC, TK-OAV081	0.280	0.200		0.005
TC, TK-HAO081	0.230	0.200		0.005
TC, TK-MDP081	0.002	0.500		0.004
<i>Isolated Discrete Relay</i>				
TC, TK-ORC081	0.100	0.100		
TC, TK-ORC161	0.150	0.150		
<i>AC Input</i>				
TC, TK-IDK161	0.003	0.125		
TC, TK-IDW161	0.002	0.100		
TC, TK-IDX081	0.002	0.100		
TC, TK-IDA161	0.002	0.100		

TC, TK-IDB321		0.002	0.165		
<i>AC Output</i>					
TC, TK-ODK161		0.002	0.300		
TC, TK-ODX081		0.250	0.175		
TC, TK-ODA161		0.002	0.400		
Model Number		current draw @ 24vdc (amps)	current draw @ 5vdc (amps)	current draw @ 3.3vdc (amps)	current draw @ 1.2vdc (amps)
<i>DC Input</i>					
TC, TK-IDJ161		0.002	0.100		
TC, TK-IDX161		0.002	0.150		
TC, TK-IDD321		0.002	0.150		
<i>DC Output</i>					
TC, TK-ODJ161		0.002	0.300		
TC, TK-ODX161		0.140	0.250		
TC, TK-ODD321		0.002	0.300		
<i>Serial Interface</i>					
TC, TK-MUX021		0.012	0.960	0.780	0.005
<i>PROFIBUS DP</i>					
SST-PFBCLX ²		0.002	0.825		
<p>0.030A of the 24 VDC is used by the RTP, 0.010A used by the TC-FFIF01. For complete FOUNDATION Fieldbus information, consult the EP03-470-200, FOUNDATION Fieldbus Specifications and Technical Data document.</p> <p>For complete PROFIBUS DP information, consult the EP03-450-200 PROFIBUS DP Specifications and Technical Data document.</p>					

8. DeviceNet Interface

8.1 Introduction

The DeviceNet interface provides a communication path from a DeviceNet network to a C200 controller through a dedicated DeviceNet Bridge (DNB) interface module. The DNB module is an Allen-Bradley-supplied device that can mount in both the Controller and the I/O rack. The diagram below depicts a topology example.

Figure 8-1 Redundant Controller Experion platform with DeviceNet Interface

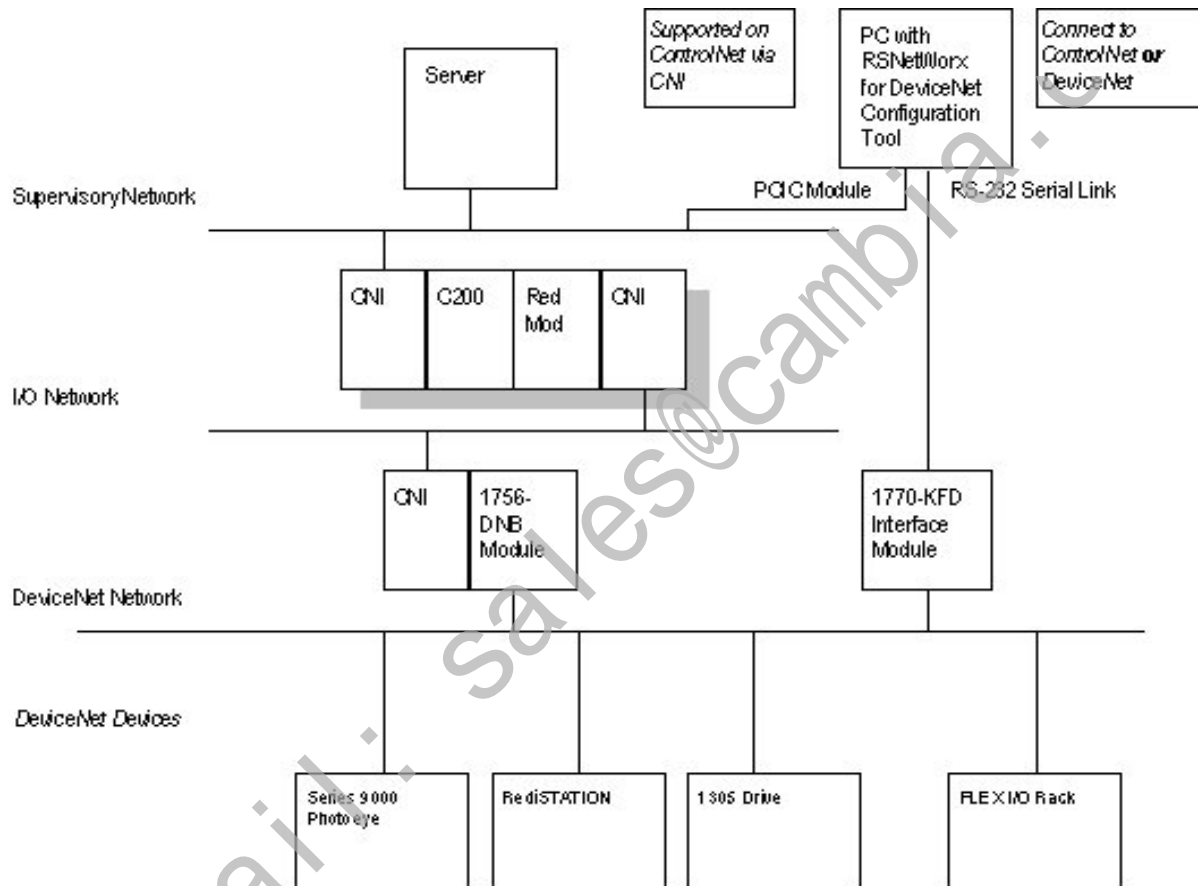

8.2 Functional Description

8.2.1 Introduction

The Experion-to-DeviceNet interface uses generic C200 Controller function blocks contained within a DeviceNet interface library (DNETIF). This library is used within Control Builder to build control strategies.

These generic blocks provide a simple interface to Open DeviceNet Vendor Association (ODVA) certified devices that support numeric and discrete data. Additional devices can be certified by contacting a Honeywell representative.

The DNETIF library is packaged as an optional Control Component Library.

8.2.2 DeviceNet Interface Library

The DeviceNet Library contains generic DeviceNet function blocks. Generic blocks offer a flexible configuration model for providing a simple interface to most devices. The goal of the generic library is to utilize one set of function blocks that can be configured for use with most DeviceNet devices. The generic DeviceNet blocks allow users to achieve read and write capability with DeviceNet devices. After installation of the DNETIF, this library is visible on the Library tab of Control Builder.

The DNETIF library is supported by Experion LS, and includes the following blocks:

DeviceNet Library Function Block	Description
DNET_IM block	An IOM block representing the DNB module.
DNET_DEVICE block	A block representing a Device.
DNET_INCHAN block	An associated input channel block representing data received from a DeviceNet device.
DNET_OUTCHAN block	An associated output channel block representing data sent to a DeviceNet device.

DNET_IM Function Block

The DNET_IM Function Block is an I/O module function block that represents the DNB Module. The DNET_IM block itself does not interpret any I/O data; it merely serves I/O data to each of its associated device blocks. It supports communication to any/all DeviceNet devices within the valid station address range of 0-63. In addition, it supports a maximum of 64 devices, identified by a unique network address. The following table shows important information that is configured using Control Builder.

Use Control Builder to configure this DNET_IM function block information
The name and type of module and the chassis address.
The Input and Output data size, and the data connection update rate.
DeviceNet configuration – A table of textual descriptors showing the configuration of the DeviceNet network, which has been configured previously using the RSNetWorx for DeviceNet configuration tool. This table shows the network address of each device, the device online/offline status, and the device communication status.

DNET_DEVICE Function Block

The DNET_DEVICE block is the generic device module block that represents the device of interest. The following table shows important information that is configured using Control Builder.

Use Control Builder to configure this DNET_DEVICE function block information:
The <i>DNET_IM</i> block that serves its I/O data.
The DeviceNet network <i>Address</i> of the DeviceNet device that the function block represents.
The <i>Format</i> of the input and output data of the device.

DNET_INCHAN Function Block

The DNET_INCHAN (Input Channel Block) represents the input received from a DeviceNet device. The following table shows important information that is configured using Control Builder.

Use Control Builder to Configure this DNET_INCHAN Function Block Information:	Description
Channel Assignment	The input channel block (<i>DNET_INCHAN</i>) is assigned to a <i>DNET_DEVICE</i> block within the same C200 control execution environment. This block type reserves one of the channels 0-15 of the <i>DNET_DEVICE</i> block for assignment. Like other Experion I/O modules, both the device block and the CM containing the input or output channels must be assigned to the same control execution environment prior to assigning the channel to the device block.
Pin Exposure	The input channel block is capable of processing up to 8 numeric inputs and 32 discrete inputs or any combination thereof; thus, the user must choose the appropriate parameters for pin exposure and connection to other blocks. One numeric input parameter and one discrete input parameter are exposed as block pins by default.
Input Channel Data Message Location	The data offset and data size of the channel block's message structure must be configured.
Numeric Input Configuration	Up to 8 numeric input parameters can be derived from the input channel. The position, type and scaling of each numeric input parameter used must be configured.
Discrete Input Data Configuration	Up to 32 discrete input parameters can be derived from the input channel. The position of each discrete input parameter used must be configured.

DNET_OUTCHAN Function Block

The DNET_OUTCHAN (Output Channel Block) represents the output sent to a DeviceNet device. The following table shows important information that is configured using Control Builder.

Use Control Builder to Configure this DNET_OUTCHAN Function Block Information:	Description
Channel Assignment	<p>The output channel block (<i>DNET_OUTCHAN</i>) is assigned to a <i>DNET_DEVICE</i> block within the same control execution environment. This block type reserves channels 16-32 of the <i>DNET_DEVICE</i> block for assignment.</p> <p>Like other Experion I/O modules, both the device block and the CM containing the input or output channels must be assigned to the same control execution environment, prior to assigning the channel to the device block.</p>
Pin Exposure	<p>The output channel block can process up to 8 numeric outputs and 32 discrete outputs.</p> <p>The user must choose the appropriate parameters for pin exposures and connections to other blocks.</p> <p>One numeric output parameter and one discrete output parameter are exposed as block pins by default.</p>
Access Level Constraints on Control Outputs	<p>A view-only access lock is enforced on the discrete and numeric output parameters of the <i>DNET_OUTCHAN</i> block; therefore, the operator/engineer cannot change the value of these parameters directly.</p> <p>Any output parameter that must be capable of being changed by the operator or engineer should be exposed as a block pin and connected to another block.</p>
Output Channel Data Message Location	<p>The data offset and data size of the device block's message structure must be configured.</p>
Numeric Output Configuration	<p>Up to 8 numeric output parameters can be derived from the output channel. The position, type and scaling of each numeric output parameter used must be configured.</p>
Discrete Output Data Configuration	<p>Up to 32 discrete output parameters can be derived from the output channel. The position of each discrete output parameter used must be configured.</p>

Generic Function Block Constraints

Generic blocks provide the Control Execution Environment (CEE) with I/O data of FLOAT64 and BOOLEAN data types only, for analog and discrete devices, respectively. However, I/O parameters can be connected to blocks such as the TypeConvert block in order to effectively interpret other data types

Although analog/numeric data is exposed to the control process in the FLOAT64 data type, as described above, the generic blocks interpret/package all numerical data in either integer or floating point format for transport from/to DeviceNet.

The following table lists the integer and floating point formats supported for data transport by the DeviceNet Interface Library generic channel blocks.

Integer and Floating-point formats supported by generic blocks

Signed 8 bit integer
Unsigned 8 bit integer
Signed 16 bit integer
Unsigned 16 bit integer

Generic blocks interpret (or package) all discrete/Boolean data as an individual bit, where the byte and bit number can be specified. Conventional logic polarity is assumed, whereby a “1” corresponds to an On/True condition and a “0” corresponds to an Off/False condition.

The use of logic blocks, such as the NOT block, can be used to effectively invert the polarity of the logical conditions.

The following table lists the configuration limits that apply to the use of generic blocks.

Device Block Configuration Limits	
Configuration Limit per Device Block	Description
Channels: 16 Input channel blocks 16 Output channel blocks	Each device block supports up to 16 input channel blocks and 16 output channel blocks.
Numerics: 128 Input Numeric values 128 Output Numeric values	Each of the 16 input and output channel blocks is capable of mapping up to 8 numeric values. 16 channels/device x 8 numerics/channel = 128 numerics/device A maximum of 128 numeric input values and 128 numeric output values per device is possible.
Discretes: 512 Input Discrete values 512 Output Discrete values	Each input and output channel is capable of mapping up to 32 discrete values. 16 channels/device x 32 discretes/channel = 512 discretes/device A maximum of 512 discrete input values and 512 discrete output values per device is possible.

Input and output parameter names are fixed at the parameter names indicated in the following table; however, 24 character descriptors are configurable on each parameter.

DeviceNet Interface Library Block I/O Parameter Names		
	Input Channel Block	Output Channel Block
Numeric Parameter Name	PV[0-7]	OP[0-7]
Discrete Parameter Name	PVFL[0-31]	OPFL[0-31]

Data Sizes

All data sizes are indicated in units of bytes. All byte and bit offsets are zero-based specifications. All data offsets are indicated in units of words and bits and are “left justified”.

Bit Offsets

All bit offsets are made relative to a particular byte, and therefore span the range 0 to 7. Bit offsets are “right justified”, meaning that when a byte is presented in binary numerical format, bit 0 is on the right side. In the following example, only bit 0 is set: 00000001.

Although input and output channel blocks are capable of specifying and interpreting a discrete value in a single bit, the entire byte (which contains the referenced bit) is read and written by the input/output channel blocks, respectively.

8.3 Data Formats

Numeric Data

Five integer formats are supported for both input and output channel blocks.

The tables below list the data types, sizes and the minimum and maximum mathematical ranges for the integer data types. This information is a property of the device of interest and must be known by the configuration engineer in order to properly configure the generic input and output channel blocks.

Numeric inputs and outputs do not support under range or over range protection in the form of fail-safe behavior nor are alarms generated at such limits.

Discrete/Boolean Data Type

The generic blocks are configured with the necessary parameters to specify the particular byte and bit necessary to convert between discrete I/O data and integer format.

8.4 Specifications

Hardware Details

The DeviceNet Bridge Module possesses the following characteristics:

Integer Data Formats Supported with DeviceNet Interface				
Data Type	Description	Size (bytes)	Minimum Value	Maximum Value
BYTE_SIGNED	Signed 8 bit integer	1	-128	127
BYTE_UNSIGND	Unsigned 8 bit integer	1	0	256
WORD_SIGNED	Signed 16 bit integer	2	-32,767	32,768
WORD_UNSIGND	Unsigned 16 bit integer	2	0	65,536

Discrete/Boolean Data Type

The generic blocks are configured with the necessary parameters to specify the particular byte and bit necessary to convert between discrete I/O data and integer format.

Parameter	Specification
Module Model Number and Type	1756-DNB/A with version 3.10 firmware; Available from Allen-Bradley; CIOM-A form-factor; single slot-width 1756-DNB/B with version 6.2 firmware; Available from Allen-Bradley;
Physical Interface	Provides a communication bridge between ControlNet and DeviceNet.
Chassis Locations	Controller or Remote I/O Chassis (as with other CIOM-A modules, it is located in the I/O Chassis in a redundant Controller configuration)
DeviceNet baud rates supported	500 KBps, 250 KBps and 125KBps
Maximum Number of 1756-DNB Modules per C200 Controller	32

Maximum Number of 1756-DNB Modules per Downlink CNI A Downlink CNI can support the equivalent of 24 IOMs.	12
Communication update between module and DNB block	50 ms
Maximum Bytes per Network	496 Input; 492 Output
Maximum Number of 1756-DNB Modules per Server (Redundant or Non-Redundant)	100
Maximum Number of DeviceNet Usage Licenses per Server (Redundant or Non-Redundant)	100
Update Rates from the 1756-DNB Module to the C200	Read at 25ms; Write at 25 ms
Configuration	Configured from a PC running the <i>RSNetWorx for DeviceNet</i> Configuration Tool connected to either DeviceNet through a 1770-KFD Interface Module or ControlNet through a PCIC Module.
<p>A DeviceNet Usage License, TC-DNLXxx, is required based on the total number of DeviceNet Bridge Modules per Server actually in use.</p> <p>1756-DNB firmware is supplied by Rockwell. To upgrade the firmware, go to Rockwell's website, http://support.rockwellautomation.com/. Rockwell no longer supports the 3.10 version of firmware Rockwell has obsoleted all firmware prior to version 6.2.</p> <p>Warning: The 1756-DNB/B module is not compatible with the 3.10 firmware. Do not flash the 1756-DNB/B module back to the 3.10 firmware.</p>	

8.5 Configuration

All devices on the DeviceNet, including the DNB modules, are configured as necessary using Allen-Bradley's RSNetWorx for DeviceNet software. Configurations of the DeviceNet and Experion networks are performed separately and differently. Experion configuration (Controller, DeviceNet Control Blocks residing in the controller, Server, Station) is performed using the normal Experion system configuration methods such as the Control Builder and Experion Station. The DeviceNet system (such as devices on DeviceNet, 1756-DNB, and DeviceNet network configuration) is performed using the appropriate DeviceNet tool such as the DeviceNet RediStation or a PC with a DeviceNet connection using RSNetWorx for DeviceNet and RSLinx.

The following tables lists the various software, hardware, and system components required to implement the DeviceNet Interface with Experion.

Table 8-1 Honeywell DeviceNet Interface Software Requirements

Software Package	Optional/ Required	Purchasable from Honeywell
Honeywell's DeviceNet Interface Library - included with the DeviceNet Usage Licenses.	Required	Yes
RSLinx or RSLinx Lite	Required	Yes
RSNetWorx for DeviceNet	Required	No
Experion Control Builder	Required	Yes
Experion DeviceNet Bridge Usage License DeviceNet Usage Licenses: TC-DNLX01: DeviceNet Usage License, 1 DNB TC-DNLX05: DeviceNet Usage License, 5 DNBs TC-DNLX10: DeviceNet Usage License, 10 DNBs <i>(these licenses are additive and ordered in quantities required for the number of DNB Modules)</i>	Required	Yes
All software not purchased from Honeywell must be acquired from their respective supplier.		

Table 8-2 Hardware Requirements for DeviceNet Configuration Tools

Hardware	Optional/ Required	Purchasable from Honeywell
PC/Laptop with Serial Port	Required	No
1770-KFD Interface Module & RS-232 cabling	Optional*	No
ControlNet through a PCIC Module and cabling	Optional*	No
Either a ControlNet Interface Card (TC-PCIC01K) or a third-party 1770-KFD is required to configure devices.		

Table 8-3 Honeywell DeviceNet Interface System Requirements

Hardware	Optional/ Required
Experion LS	Required
1756-DNB - Allen-Bradley DeviceNet Bridge device	Required
C200E/C200 Controller	Required
DeviceNet network	Required

9. PROFIBUS Integration

9.1 Introduction



PROFIBUS is a supplier-independent, open field bus standard for a wide range of applications in manufacturing and process automation. PROFIBUS DP is the most frequently used communication profile in PROFIBUS. It is optimized for speed, efficiency and low connection costs and is designed especially for communication between automation systems and distributed peripherals.

The Experion LS to PROFIBUS DP interface provides a communication path from the PROFIBUS network to the C200 controller through a dedicated hardware interface card. The PROFIBUS Interface Module (**PBIM**) is manufactured and delivered by SST Technologies. The PBIM is fully qualified and supported by Honeywell.

Form factor and mounting: The SST PBIM is a single-wide module and resides in a standard Chassis Series-A (CIOM-A) chassis slot position. The module provides the interface between a Profibus DP network and the C200 Control Processor. Although the PBIM cannot be redundant, it can be used in Non-redundant or redundant C200 processor configurations.

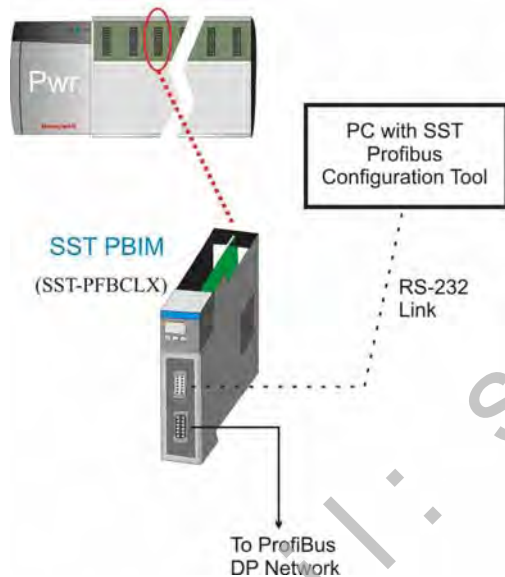

Profibus Network Connection:

The PBIM provides connection to one Profibus DP network. The PBIM is a PROFIBUS DP Class 1 Master; capable of functioning in 'multi-master' configurations. PROFIBUS DP supports both stand-alone and modular I/O devices and multiple PBIM modules can be used either on separate PROFIBUS DP networks or on the same PROFIBUS network (a multi-master configuration).

SST Configuration tool: The PBIM and PROFIBUS network settings are configured using the RS-232 connection and a dedicated SST PROFIBUS configuration tool.

Control Builder: The Input/output data accessed from the Profibus Slaves (devices) is easily integrated into the control strategy using Profibus specific function blocks and the Control Builder environment.

Figure 9-1 PROFIBUS Interface Module

9.2 Functional Description

Introduction

Experion-to-PROFIBUS interfacing is performed using generic or device-specific function blocks contained within a PROFIBUS interface library. This library is used with the Experion Control Builder to create control strategies within the Experion controller.

The generic PROFIBUS function blocks provide a simple interface to most PROFIBUS devices. Device Specific function blocks are only usable with the devices they represent. These specific function blocks provide simpler configuration and all supported functions can be accomplished using either function block. The PROFIBUS library is provided in the standard Experion Control Builder library set. Additional application specific libraries can be provided as an optional Control Component Library.

9.3 PROFIBUS DP Overview

PROFIBUS DP is a master/slave, token passing network, which utilizes a request/response protocol. Basic data exchange operations ensure that on a periodic basis, the master sends an output message to each slave, which responds in turn with an input message. PROFIBUS DP is typically used as an I/O network. As compared to a traditional I/O network architecture that requires dedicated wiring between each I/O module and the controller device, PROFIBUS offers the advantage of a single network/bus on which all I/O peripheral devices reside.

Fiber Optic

Since the physical interface to Experion currently employs an electrical connection, the use of fiber optic media will not be discussed in this document. It is expected however that various commercially available products can be used with the Experion system, which will allow the use of electrical, as well as fiber optic media on a PROFIBUS DP network.

Bus Wiring (electrical)

PROFIBUS DP utilizes a “daisy-chain” bus topology, with a single PROFIBUS cable wired from the master to the first slave and through each slave in the network. “Branches” can be supported through the use of segments, isolated by repeaters, which are described briefly below.

The electrical wiring media used for PROFIBUS is a shielded twisted pair (2 conductors plus the shield). Specialized cable that meets the PROFIBUS application is commercially available.

The connectors used are typically a 9 pin Sub-D connector, with pins 3 and 8 used for the positive/negative data signals. Refer to wiring diagrams for the equipment in use for additional details.

The devices at the ends of each segment require active termination, the circuitry for which is generally specified on a per-device basis. Alternatively, PROFIBUS connectors with an integrated termination circuit are commercially available.

Refer to the device technical documentation for additional details on wiring and termination.

Device Profiles

Due to the lack of definition at the presentation layer, the PROFIBUS Trade Organization (PTO) has defined a set of device profiles that provide some level of standardization for certain complex devices. These profiles are not formally a part of the PROFIBUS protocol definition, so they are not considered a part of the PROFIBUS communication model depicted above. However, for certain devices these device profiles provide some degree of standardization at the data management layer. Note that device vendors are not required to utilize these profiles.

The set of available profiles include the following:

- Profile for communication between controllers
- Profile for process control devices
- Profile for NC/RC controllers (robotics)
- Profile for variable speed drives
- Profile for Encoders
- Profile for HMI systems
- Profile for safety

9.4 PROFIBUS Interface Architecture

PROFIBUS DP Network Topology

Several unique types of devices can exist on a PROFIBUS network. The sections below provide a brief summary of the terminology.

Typical PROFIBUS DP Topology Diagram

The following diagram depicts the basic components in a typical PROFIBUS DP network, and a possible set of station and module number assignments. Specific definitions are cited in the sections to follow.

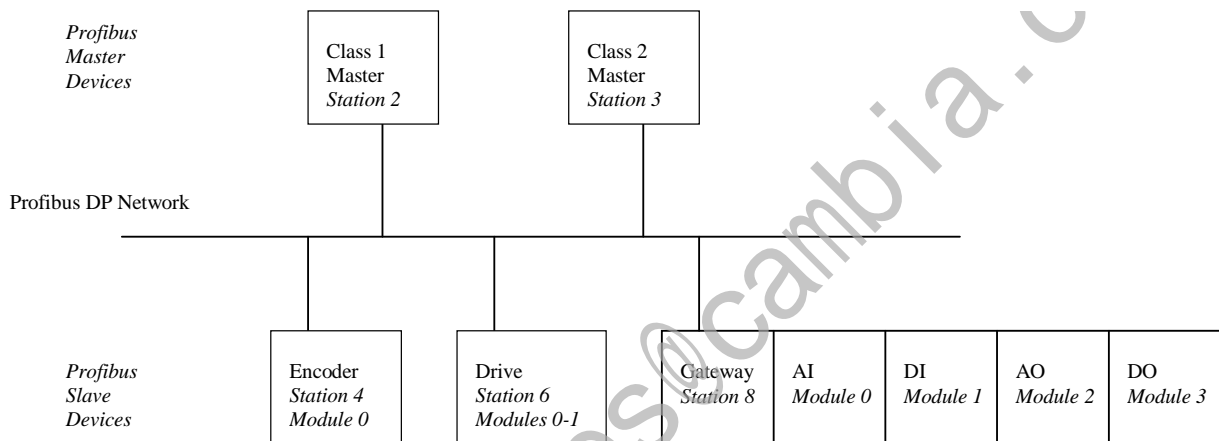

In this architecture, individual slave devices can utilize multiple “virtual” modules, which is common with complex devices such as motor-drives (frequency converters). In normal cyclic communication operations, the class 1 master communicates with each slave station, not necessarily directly with each module. In the example of the modular I/O station (#8), the Class 1 master exchanges I/O data with the station or “gateway module”, which in turn disseminates the appropriate portions of the message to/from each module. In this example, each PROFIBUS (data) module is equivalent to one physical module.

9.5 Stations

A station is any node on the network with a unique PROFIBUS physical address, which includes master devices, slave devices, communication interfaces/gateways and segment repeaters. Up to 126 unique stations, can be configured on a PROFIBUS DP network. The valid station address range spans from 0 to 125.

“Physical” Modules

With some devices, there exists a one-to-one correspondence between physical devices and PROFIBUS modules. For example, a typical rack/rail I/O system on PROFIBUS may contain several different interchangeable physical I/O modules. When this system is configured on PROFIBUS, each physical device is represented as one “module” on PROFIBUS.

“Virtual” Modules

With other devices, such as motor drives, a single physical device may be represented as multiple PROFIBUS modules. This simply means that if the device accepts/provides many bytes of I/O data, the data may be split up into multiple parts, each of which is considered a different module. In this context, the term “module” can be confusing. It can more appropriately be conceived of as a “virtual module” or “data object”.

Slave Configuration using GSD Files

PROFIBUS supports a uniform standard for the configuration of PROFIBUS slaves/modules that utilizes GSD files which allows “open” configuration of PROFIBUS devices. A GSD file is essentially an electronic data description of a slave device. In accordance with a standard format, the GSD file is a text file that is defined and supplied by the device vendor. The file can be imported and interpreted by the DP Master Class 2 device such that it can supply the user with an interface to configure the slave device. Essentially, the GSD file and supporting infrastructure provides a uniform method of defining the configuration profile of a slave device such that any DP Master Class 2 configuration tool can be used to configure any slave device.

9.6 Control Processor Integration

C200 Integration

Refer to Figure 9-1 PROFIBUS Interface Module The SST PBIM (ProfiBus Interface Module) can be inserted into a Local (Downlink C200) chassis slot position (when C200 is not redundant) and/or any Uplink (remote) I/O chassis slot position. The PBIM can be implemented on an I/O Control Network along with Rail-A module. The PBIM can also be used in configurations that include PMIO (not shown in the diagram). The total number of PBIM's that can be interfaced to one C200 must be calculated based on the mix of I/O types, families, and the topology implemented with the C200.

General limits (PBIM only, no other I/O types or families implemented):

Parameter ¹	Specification ¹
Maximum Number of ProfiBus modules per C200 Controller.	10
Communication update between ProfiBus module and C200 PBIM block. User configurable (PUBRATE) range	Local (C200) Chassis: 5 ms – 50 ms Remote (Downlink) Chassis: 12.5 ms – 50 ms
IOM loading. When mixing other I/O modules with the Profibus module on the same C200 how much of this resource is used by the Profibus Module.	See Error! Reference source not found. in CEE Section.
Maximum Number of ProfiBus modules per Downlink CNI <i>A Downlink CNI can support the equivalent of 24 IOMs. Maximum (4) Downlink CNI's per C200.</i>	(4) when module is set to 25 mSec (and above) update rate (2) when module is set to at 12.5 mSec (and below) update rate
¹ May be further limited by the mix of other I/O and network modules used.	

C200 Implementation

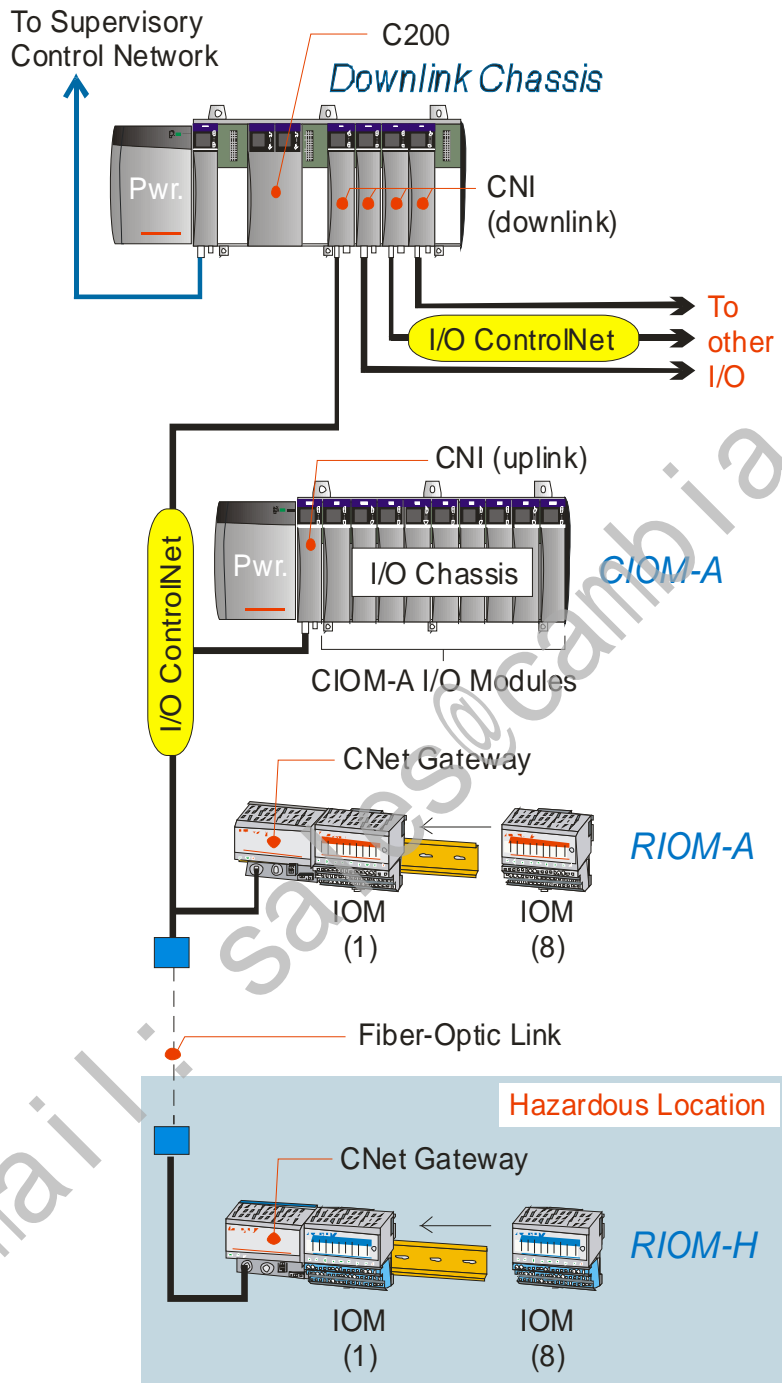

9.7 Specifications and Capacity

The information in this section is intended to provide a set of specifications that bound the system topology given the introduction of the PROFIBUS interface.

SST-PFBCLX Module Specifications

PROFIBUS Interface Module (PBIM)

Specifications	Parameters
Module Type	CIOM-A form-factor; single slot-width
Physical Interface	PROFIBUS DP Class 1 Master; capable of functioning in 'multi-master' configurations.
Chassis Locations	Non-redundant Controller or Remote I/O Chassis (does not support redundancy)
Number of Networks / PBIM	1 (plus one RS232 configuration port)
Support for PROFIBUS Slave Diagnostics	Configurable up to 244 bytes
Valid PROFIBUS Station address range	0 – 125 ¹
Maximum number of modules per PBIM block (identified by a unique station/module number combination)	100
Maximum Input Data Size per PFB Module (all slave stations)	496 bytes (valid range = 4-499)
Maximum Output Data Size per PFB Module (all slave stations)	492 bytes (valid range = 4-495)
PROFIBUS Device Profiles Supported (with custom function blocks)	PROFIDRIVE, Encoder
Devices supported with custom function blocks	Siemens Simatic® ET200M I/O, Siemens Simocode 3UF5 Motor Protection and Control Unit, Bizerba Weighing Terminal ST
Data types supported by the "Generic" PROFIBUS Channel Blocks ²	Single bit (Discrete), 8 bit signed/unsigned integer, 16 bit signed/unsigned integer, 32 bit signed integer, 32 bit IEEE floating point
PROFIBUS Baud Rates Supported	12 Mbps, 6 Mbps, 3 Mbps, 1.5 Mbps, 500 Kbps, 187.5 Kbps, 93.75 Kbps, 19.2 Kbps, 9.6 Kbps
PROFIBUS Electrical Connection	9 Pin Female – Optically Isolated
Vibration & Shock ²	10 to 50 Hz, 5 g, 30 g peak, 11 ms
<p>¹ The maximum number of supportable devices per network is highly dependent on application, bandwidth, devices, available current, bus length and topology. An understanding of PROFIBUS is crucial to system sizing.</p> <p>² Note vibration and shock spec different from general spec.</p> <p>A PROFIBUS Usage License, TC-PBLXxx, is required based on the total number of PFBs per Server actually in use.</p>	

Other notable module specifications include:

- The module internally stores the PROFIBUS configuration into flash-ROM, and supports automatic reconfiguration of slave devices on repower.
- Input and output messages from/to the various PROFIBUS station/slave devices are 'bundled' at the ControlNet level into 2 assemblies (data objects) which are available for transport across ControlNet from/to the C200:
 - As configured with the PROFIBUS network configuration, all input data messages (from PROFIBUS input devices) are packed into a 496 byte input assembly. Input data is bound from input devices to the C200.
 - As configured with the PROFIBUS network configuration, all output data messages (from PROFIBUS input devices) are packed into a 492 byte output assembly. Output data is bound from the C200 to the output device. Acyclic services associated with the PROFIBUS DP-V1 extension are supported.

The **PROFIBUS Interface Module** hardware is produced and distributed by Woodhead SST. They deliver the module with a supporting set of software utilities used for configuration, monitoring, and documentation/help. Their PROFIBUS Module model number is SST-PFB-CLX.

SST/Woodhead Connectivity
 50 Northland Road
 Waterloo, ON N2V 1N3

Or <http://www.mysst.com/bcm/pfbclx.asp>

9.8 PROFIBUS Cable Characteristics

The following are characteristics of the PROFIBUS Interface Cable:

Cable	PROFIBUS (type A)
Impedance	35 up to 165 Ohm
Capacity	< 30 pF /meter
Diameter	AWG 22
Type	Twisted pair
Resistance	<110 Ohm/kilometer
Attenuation	Max. 9 db over length of line section
Shielding	CU Braid or shielding braid and shielding foil

9.9 Configuration Tools

Each affected hardware component in the Experion PROFIBUS architecture requires specific configuration tools as listed in the table below:

Component	Configuration Tool
SST-PFBCLX	SST PROFIBUS Configuration Tool
PROFIBUS Network	SST PROFIBUS Configuration Tool
Slave Module/Station/Device (using GSD file)	SST PROFIBUS Configuration Tool
All Experion LS Blocks	Experion Control Builder

9.10 PROFIBUS Licenses

PROFIBUS licensing is required to use the PROFIBUS Interface Module. Licenses are assigned per module. When loading a CM to a particular PROFIBUS Module (PBIM), adequate licensing will be confirmed. An error will be returned if insufficient licenses are available. Licenses are additive. This allows for the ability to incrementally add licenses if required. For example, if four PROFIBUS Modules are required, the system would be required to purchase four TC-PBLX01 licenses. The table below depicts the available license increments.

Model Number	Description
TC-PBLX01	PROFIBUS Usage License, 1 PBIM
TC-PBLX05	PROFIBUS Usage License, 5 PBIMs
TC-PBLX10	PROFIBUS Usage License, 10 PBIMs

email: sales@cambia.com

9.11 Generic PROFIBUS I/O Blocks

9.11.1 Introduction

The “generic” PROFIBUS blocks described in this section consist of a module block, an input channel block and an output channel block, that are capable of being configured to provide a simple interface to most PROFIBUS DP devices. They’re referenced as “generic” blocks because they have not been designed for the sole purpose of interfacing to a specific device.

Template Names

The block template names for the generic blocks are the following:

- PBI_DEVICE – Generic device/module block
- PBI_INCHAN – Generic input channel block
- PBI_OUTCHAN – Generic output channel block

Data Formats

Because PROFIBUS DP does not enforce the use of a standard for structured data, such as floating point values, integer values, Boolean/discrete values, enumeration ordinals, etc., there exists a great variation in how data messages are formatted and interpreted amongst the vendor community. Thus, data interpretation is a complex problem for the controller. In fact, it would be virtually impossible to create a single function block that could anticipate every possible means of data representation.

The data formats for the messages for a particular device are generally specified in the technical documentation that accompanies the device. The GSD file generally does not contain all of the information necessary to interpret or assemble the data messages for a particular device.

Numeric/Real Data Types

Typical Numeric Data Representation on PROFIBUS DP

Numerical data (such as real or integer numbers) is most commonly transported across PROFIBUS DP in integer format. Real numbers are converted to/from integer values through a simple linear conversion process.

For example, the following equations show how a 4-20 mA value could be represented using a 16 bit unsigned integer.

Bottom of raw integer value range = -20,000 = 4 mA = 0%

Top of raw integer value range = 20,000 = 20 mA = 100%

Each equation represents a unique point on a linear equation, and any two points define a line, from which a linear conversion equation can be derived.

Numeric Data Handling Capability in the Generic Channel Blocks

The generic blocks are configured with the necessary linear scaling parameters necessary to convert I/O data from/to integer format.

Five integer formats are supported for both input and output channel blocks. The table below lists the data types, sizes and the minimum and maximum mathematical ranges for the data types. This information is a property of the device of interest and must be known by the configuration engineer in order to properly configure the generic input and output channel blocks.

Data Type	Description	Size (bytes)	Minimum Value	Maximum Value
BYTE_SIGNED	Signed 8 bit integer	1	-128	127
BYTE_UNSIGND	Unsigned 8 bit integer	1	0	256
WORD_SIGNED	Signed 16 bit integer	2	-32,767	32,768
WORD_UNSIGND	Unsigned 16 bit integer	2	0	65,536
DWORD_SIGNED	Signed 32 bit integer	4	-2,147,483,648	2,147,483,647

Discrete/Boolean Data

Discrete Data Representation on PROFIBUS DP

Discrete (Boolean) data is generally represented on PROFIBUS DP as a specific bit, which may be packed into an array of bits, where each of 8 bits per byte represents a different discrete value.

Discrete data handling capability in the generic channel blocks

The generic blocks are configured with the necessary parameters to specify the particular byte and bit necessary to convert discrete I/O data from/to integer format.

Scope of Application

This section provides the available information necessary to determine whether the generic blocks are applicable for use with a particular device. This determination is not easily made given that it also requires intimate knowledge of the input/output data message structure for the device of interest.

Application Constraints

The data representation of various PROFIBUS DP devices was considered in the design of the generic blocks. As a result, these blocks can interface with most, but not all, PROFIBUS DP devices. The following constraints bound the scope of application:

- The generic blocks provide the CEE with I/O data of FLOAT64 and BOOLEAN data types only, for analog and discrete devices, respectively. Note that I/O parameters can be connected to blocks such as the TypeConvert block in order to effectively interpret other data types.
- Although analog/numeric data is exposed to the control process in the FLOAT64 data type, as described above, the generic blocks interpret/package all numerical data in integer format for transport from/to PROFIBUS. The following integer formats are supported for data transport by the generic channel blocks:
 - Signed or unsigned 16 bit integer (most commonly used)
 - Signed or unsigned 8 bit integer
 - Signed 32 bit integer

- The generic blocks interpret/package all discrete/Boolean data as an individual bit, where the byte and bit number can be specified. Conventional logic polarity is assumed, whereby a “1” corresponds to an On/True condition and a “0” corresponds to an Off/False condition. Note that the use of logic blocks, such as the NOT block, can be used to effectively invert the polarity of the logical conditions.
- The generic blocks are capable of interpreting I/O data that is of a fixed format; I/O data of variable format cannot be interpreted. An example of a fixed format device is a 4-channel AI module that provides an 8-byte input data structure, with 2 bytes representing each channel. An example of a variable format data structure is a 6-byte output data structure where the first two bytes specify a numerical parameter identifier (selects one of several parameters) and the remaining 4 bytes represent the value that is being stored.
- The generic output channel blocks do not provide back-initialization capability to any regulatory control blocks that are connected.

Configuration Guidelines and Considerations

The following configuration guidelines apply to the use of the generic PROFIBUS blocks:

- A maximum of up to 16 input channels and 16 output channel blocks can be associated with the device/module block.
- Each input and output channel is capable of mapping/interpreting up to 8 numerical values. At 16 channels per module, this provides a maximum of 128 numerical values per device/module.
- Each input and output channel is capable of mapping/interpreting up to 32 discrete values. At 16 channels per module, this provides a maximum of 512 discrete values per device/module.
- Input and output parameter names are fixed at the parameter names indicated in the following table. However, 24 character descriptors are configurable on each parameter.

	Input Channel Block	Output Channel Block
Numeric Parameter Name	PV[0-7]	OP[0-7]
Discrete Parameter Name	PVFL[0-31]	OPFL[0-31]

- All data sizes are indicated in units of bytes.
- All byte and bit offsets are zero based specifications. Therefore, the first byte of a data message is considered byte 0, not byte 1. A data message of 8 bytes in size would span bytes 0-7.
- All data offsets are indicated in units of bytes and are “left justified”, meaning that byte 0 is the byte at the lowest memory address location.
- All bit offsets are made relative to a particular byte, and therefore span the range 0 to 7. Bit offsets are “right justified”, meaning that when a byte is presented in binary numerical format, bit 0 is on the right side. In the following example, only bit 0 is set: 00000001
- Although the input and output channel blocks are capable of specifying and interpreting a discrete value in a single bit, the entire byte (which contains the referenced bit) is read and written by the input/output channel blocks, respectively. Although this is not a problem for inputs, it does present a problem for outputs. For example, if two different output channel blocks are used to write discrete output values that are contained within the same byte of the channel output data message, the execution order of the channel blocks and/or their containing Control Modules will determine which values are written to the device. Thus it is recommended that all discrete output channel values that are contained within a specific byte be referenced from a single output channel block.
- Numerical inputs and outputs do not support under-range or over-range protection in the form of fail-safe behavior nor are alarms generated at such limits.

10. Rail I/O – Series A Specifications

10.1 Hardware and Communications Features

Modular Design for Mounting and Operating Flexibility

The modular design of the RIOM-A line can lower installation, wiring, and maintenance costs. All components simply snap together and mount onto a 35 mm by 7.5 mm or 15 mm, metal, top hat, rail (DIN EN50022).

Simple assembly:

- The ControlNet Gateway is snapped onto the Din rail.
- The first Terminal Base is then snapped onto the rail and connects to the right side of the Gateway.
- The user can then interconnect up to (7) more Terminal Bases allowing a maximum of (8) per Gateway. The communication bus is formed as the Gateway and Terminal Base units are connected together.
- The user can then complete the field wiring and power connections to each Terminal Base unit. Power (module and field) is supplied by external power supplies.
- Once the Terminal Base units are in place, the user then snaps the desired I/O module onto the correct base. Each Terminal Base features a mechanical key to ensure the correct I/O module is plugged into the correct base. I/O modules can be quickly removed and inserted without disturbing the field wiring.

RIOM-A Modules can be mounted horizontally or vertically. The optional **Terminal Base Extender** Cable allows for even greater mounting flexibility. The Extender Cable can be installed between any two Terminal Bases allowing for different mounting configurations to meet the needs of different cabinets.

Addressing, and IOM Group and Channel Numbering

A single Gateway can handle communications with up to eight IOM's (I/O Modules) in any combination of available module types. Using a thumb wheel setting on the Gateway, each Gateway is given a unique address on the I/O ControlNet. Each IOM then assumes a unique **IOM Group** number from 0 through 7 based on its physical position relative to the gateway. The IOM connected to the Gateway is always IOM Group zero, the next IOM is one, and so on up to seven.

According to the IOM type selected, each IOM will provide a number of field Inputs or Outputs. Each input/output is identified as an I/O channel. Channel numbers begin at zero and go to the maximum number provided by the particular IOM.

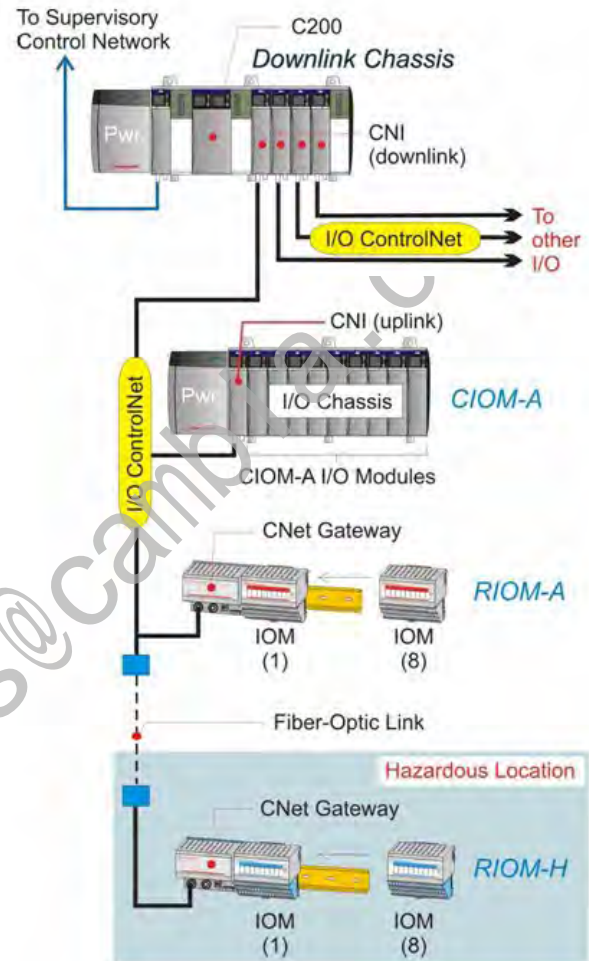
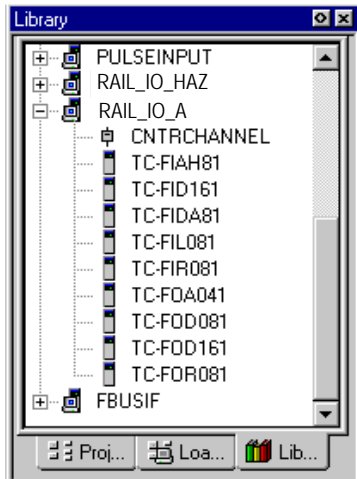

Figure 10-1 I/O Control Network Overview

Integration into Experion's Control Strategy Configuration



RIOM-A is fully integrated with the Experion system and the **Control Builder** application. Hardware configuration, I/O configuration, and assignments of I/O channels within the control strategy are completed using predefined function blocks.

Since RIOM-A components have been functionally integrated with the Experion platform, the Control Builder includes Series A Rail I/O module Function Blocks in its Library database. This means each RIOM-A block has an associated configuration form for defining its configurable attributes. These attributes include naming and identifying the component's location within the network as well as setting module and channel specific parameters, as applicable.

The intuitive and graphical nature of Control Builder along with a very tight integration makes RIOM-A setup and implantation quick and easy. Life cycle tasks are also supported by a comprehensive set of standard displays to support engineering, operations, and maintenance activities.

Powerful Support Tools

Several tools are available to provide complete monitoring and calibration services. The Network Tools (**NTOOLS**) application supplied with Experion engineering tools is used to monitor and interact with the ControlNet Network and connected RIOM-A and CIOM-A. NTOOLS provides a network centric view that allows the user to monitor network relevant information and manage firmware upgrades.

The RIOM-A system components are displayed consistently similar to other Controller and Chassis I/O components. The ControlNet Gateway always appears as the leftmost component in the RIOM-A segment graphic representation in the Detail pane of NTOOLS. Only the Gateway supports firmware loads through NTOOLS – All other RIOM-A modules do not support loadable firmware.

The IO Maintenance Tool (**IOTOOL**) application supplied with Experion engineering tools supports calibrating Rail I/O modules. The RIOM-A system components are accessed by identifying the ControlNet Gateway segment by its MAC ID (Network Address). The Rail I/O module is identified by its slot number or group position in the segment.

Product Information

The Experion Rail I/O - Series A hardware consists of the following DIN rail mounted items:

- ControlNet Gateway module (Redundant and Single Media versions)
- Terminal Bases (up to eight per Gateway) extend the Gateway's backplane bus, provide mounting for one I/O module, and provide the connection point for the field wiring associated with each IOM.
- Power supply module (24 VDC @ 1.3 amps)
- AI, AO, DI, and DO Input/Output Modules (Each Terminal base accommodates one IOM)
- The Terminal Base Extender Cable (1 foot or 3 feet) provides additional cabinet and mounting flexibility by extending the Gateway's backplane bus between terminal bases mounted on physically separate DIN rails.

Table 10-1 Rail I/O Modules – Series A

Model Number	Model Description	Number of Channels	Terminal Base Recommended
Power Supply			
TC-FFPCX1	24 vdc (1.3 Amp) Power Supply		
I/O Modules			
TC-FIDA81	120 Vac Digital Input	8	TC-FTB301
TC-FODA81	120 Vac Digital Output	8	TC-FTB301
TC-FID161	24 Vdc Sink Digital Input	16	TC-FTB301
TC-FOD161	24 Vdc Source Digital Output - Protected	16	TC-FTB301
TC-FID321	24 Vdc Sink Digital Input	32	TC-FTB321
TC-FOD321	24 Vdc Source Digital Output - Protected	32	TC-FTB321
TC-FIAH81	High Level Analog Input	8	TC-FTB301
TC-FIA121	High Level Analog Input	12	TC-FTB3G1
TC-FOA041	Analog Output	4	TC-FTB301
TC-FOA121	Analog Output	12	TC-FTB3G1
TC-FIR081	3-wire RTD Analog Input	8	TC-FTB301
TC-FIL081	Thermocouple Analog Input	8	TC-FTB3T1
TC-FOR081	Relay Digital Output	8	TC-FTB301
Gateways			
TC-FCCN01	ControlNet Gateway, Non-Redundant Media		
TC-FCCR01	ControlNet Gateway, Redundant Media		
Terminal Base			
TC-FTB301	3 - Wire Terminal Base		
TC-FTB3T1	3 - Wire Temperature Terminal Base		
Bus Extender Cable			
9900-CE1	Terminal Base Extender Cable 1 FT		
9900-CE3	Terminal Base Extender Cable 3 FT		

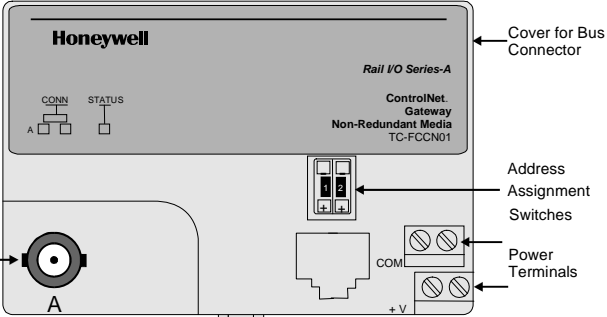
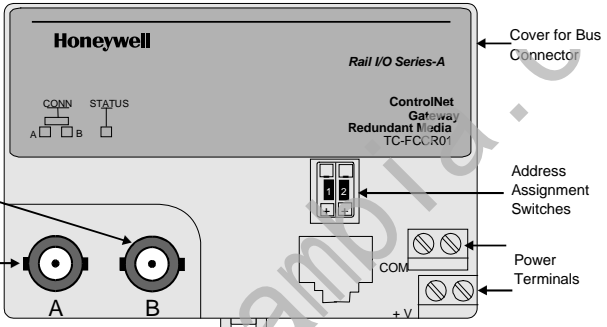
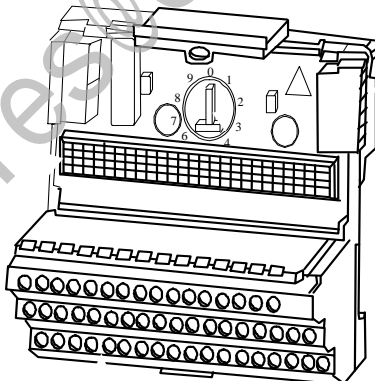
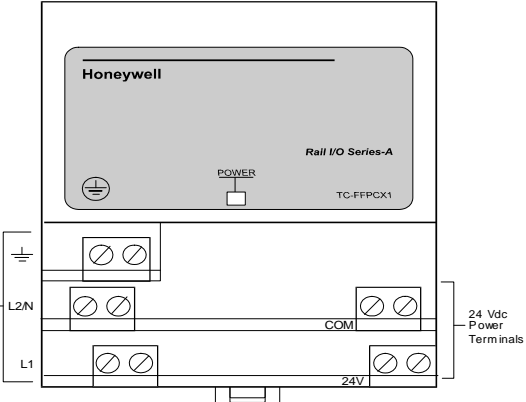
Component	View
<p>ControlNet Gateway – Non-Redundant Media TC-FCCN01</p>	
<p>ControlNet Gateway – Redundant Media TC-FCCR01</p>	
<p>Terminal Base with Screw Clamps</p>	
<p>Power Supply TC-FFPCX1</p>	

Planning Considerations

Summary of I/O ControlNet Limits

Item	Limit	See
Maximum number of CNI modules/Downlink chassis	4	
Maximum number of uplink CNI's (I/O chassis) and Gateways per downlink CNI	8	
Maximum number of I/O units per downlink CNI	24	Note-1
Maximum I/O units per C200	64	Note-1 & 2
Note-1: In most cases an I/O unit is one I/O module. Some module types (like the SI and Profibus module) will consume more than one I/O unit. See EP03-300-rrr document for details. Note-2: PMIO (connected through the IOLIM) will also consume this resource.		

Power Distribution and Supply Considerations

The figure below shows how power is distributed through an RIOM-A system and how it is related to data communications. The 24Vdc Power supply provides power to the Gateway. The Gateway, in turn, powers the internal logic through the I/O Bus for as many as eight I/O modules. The user must connect an external power supply to the Terminal Base to provide additional I/O module and field device power. The I/O module contains the Bus interface and circuitry for signal processing and data transfer. Please refer to the Table in the next section *Determining power supply requirements* for a list of individual module Bus current and external power requirements.

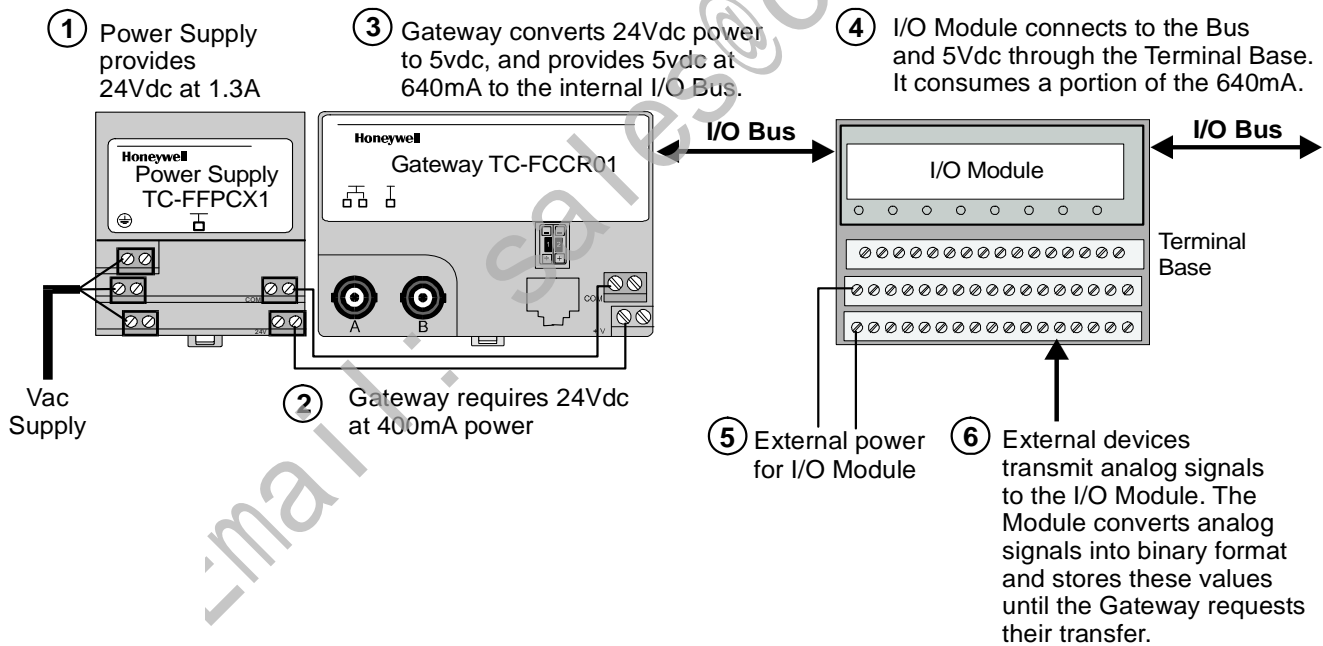

Figure 10-2 Overview of RIOM-A power distribution.

Each RIOM-A power supply can handle up to four ControlNet Gateways. The following table lists the I/O Bus current and power dissipation in Watts for the given RIOM-A component for reference.

Component	Model Number	I/O Bus Current (mA) @ 5Vdc	External Power Requirement	Power Dissipation (Watts)
ControlNet Gateway, Non-Redundant Media	TC-FCCN01	-	24Vdc	4.6
ControlNet Gateway, Redundant Media	TC-FCCR01	-	24Vdc	4.6
High Level Analog Input	TC-FIAH81	20	24Vdc	3
24 Vdc Sink Digital Input	TC-FID161	30	24Vdc	6.1
120 Vac Digital Input	TC-FIDA81	30	120Vac	4.3
24 Vdc Sink Digital Input	TC-FID321	25	24Vdc	6.0
Thermocouple Analog Input	TC-FIL081	20	24Vdc	3
3-wire RTD Analog Input	TC-FIR081	20	24Vdc	3
High Level Analog Input	TC-FIA121	80	24Vdc	1.2
Analog Output	TC-FOA041	20	24Vdc	4.5
Analog Output	TC-FOA121	80	24Vdc	4
24 Vdc Source Digital Output	TC-FOD161	80	24Vdc	5.3
24 Vdc Source Digital Output	TC-FID321	80	24Vdc	5.3
120 Vac Digital Output	TC-FODA81	80	120Vac	5.2
Relay Digital Output	TC-FOR081	69	24Vdc	5.5
24 Vdc, 1.3 Amp Power Supply	TC-FFPCX1	-	120Vac	21

Selecting an Enclosure

To meet EMC directive requirements, you must mount all components in an enclosure. You can mount the RIOM-A components in either a horizontal or vertical arrangement. You must always install the ControlNet Gateway at the left end of an I/O module segment. Since ambient temperature can affect the working life of components, you must calculate the maximum ambient temperature inside an enclosure based on the power dissipation of the installed components and the thermal characteristics of the enclosure. Consider the following things when selecting an enclosure for RIOM-A components:

- The number of RIOM-A components to be installed in one enclosure, including power supplies.
- Are all the components to be mounted in one large enclosure or several small enclosures?
- What are the thermal dynamics of the enclosure?
- Will component heat dissipation cause the interior temperature to exceed 55 °C (131 °F)?

Using Bus Extension Cable Accessories

The following bus extension cables are available to connect split DIN Rail configurations together.

- TC-PKTX30: 30 cm (12 in) long, two female connectors
- TC-PKTX90: 90 cm (36 in) long, two female connectors

Use the TC-PKTXxx cables to join rails in a split configuration as shown below. You can use only one bus extension cable per I/O segment. Once you plug the cable connectors into the corresponding backplane bus connectors on the Terminal Bases, secure the cable connectors to the panel with the hardware supplied.

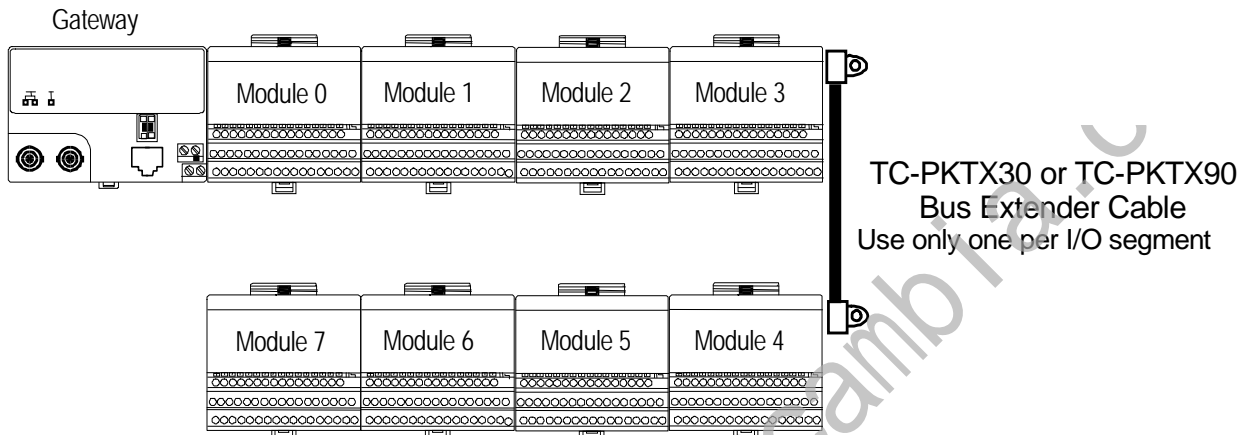

Figure 10-3 Using bus extension cable to connect split rail I/O segment.

10.2 Module Specifications

Table 10-2 TC-FCCN01 - ControlNet Gateway, Non-Redundant Media



Parameter	Specification
I/O Capacity	8 modules
Connector Screw Torque	7-9 inch-pounds
Power Supply Note:	In order to comply with CE Low Voltage Directives, you must use a Safety Extra Low Voltage (SELV) or a Protected Extra Low Voltage (PELV) power supply to power this adapter.
Input Voltage Rating	24V dc nominal
Input Voltage Range	19.2V to 31.2V dc (includes 5% ac ripple)
Communication Rate	5M bit/s
Supports Redundant ControlNet Cabling	No
Indicators	Comm A - red/grn I/O Status - red/grn
Programming Ports	1 RJ-45 Network Access Port (NAP) for use with ControlNet programming cable (e.g. 1786-CP cable) (not supported)
Flexbus Output Current	640mA maximum @ 5V dc
Isolation Voltage	500V ac between user power and flexbus
Power Consumption	400mA maximum from external 24V supply
Power Dissipation	4.6W maximum @ 19.2V dc
Thermal Dissipation	15.7 BTU/hr @ 19.2V dc
General Specifications	
Dimensions HxWxD	87mm x 94mm x 69mm (3.4in x 3.7in x 2.7in)
Environmental Conditions	
Operational Temperature	0 to 55°C (32 to 131°F)
Storage Temperature	-40 to 85°C (-40 to 185°F)
Relative Humidity	5 to 95% non-condensing
Shock	30g peak acceleration, 11(±1)ms pulse width 50g peak acceleration, 11(±1)ms pulse width
Vibration	Tested 5g @ 10-500Hz per IEC 68-2-6
ControlNet Cable	Belden RG-6/U Quad Shield
Power Conductors	Copper (stranded or solid)
Type	12 gauge (4mm ²) stranded maximum
Wire Size	3/64 (1.2mm) inch insulation max.
Agency Certification	  Groups A, B, C, D certified Class I Division 2 certified Class I Zone 2 Group IIC certified 

Table 10-3 TC-FCCR01 - ControlNet Gateway, Redundant Media



Parameter	Specification
I/O Capacity	8 modules
Connector Screw Torque	7-9 inch-pounds
Power Supply Note:	In order to comply with CE Low Voltage Directives, you must use a Safety Extra Low Voltage (SELV) or a Protected Extra Low Voltage (PELV) power supply to power this adapter.
Input Voltage Rating	24V dc nominal
Input Voltage Range	19.2V to 31.2V dc (includes 5% ac ripple)
Communication Rate	5M bit/s
Supports Redundant ControlNet Cabling	Yes
Indicators	Comm A - red/green (channel A) Comm B - red/ green (channel B) I/O status -red/ green
Programming Ports	1 RJ-45 Network Access Port (NAP) for use with ControlNet programming cable (e.g. 1786-CP cable) (not supported)
Flexbus Output Current	640mA maximum @ 5V dc
Isolation Voltage	500V ac between user power and flexbus
Power Consumption	400mA maximum from external 24V supply
Power Dissipation	4.6W maximum @ 19.2V dc
Thermal Dissipation	15.7 BTU/hr @ 19.2V dc
General Specifications	
Dimensions HxWxD	87mm x 94mm x 69mm (3.4in x 3.7in x 2.7in)
Environmental Conditions:	
Operational Temperature	0 to 55°C (32 to 131°F)
Storage Temperature	-40 to 85°C (-40 to 185°F)
Relative Humidity	5 to 95% non-condensing
Shock: Operating	30g peak acceleration, 11(±1)ms pulse width
Shock: Non-operating	50g peak acceleration, 11(±1)ms pulse width
Vibration	Tested 5g @ 10-500Hz per IEC 68-2-6
ControlNet Cable	Belden RG-6/U Quad Shield
Power Conductors	
Type	Copper (stranded or solid)
Wire Size	12 gauge (4mm ²) stranded maximum 3/64 (1.2mm) inch insulation max.
Agency Certification	  Groups A, B, C, D certified Class I Division 2 certified Class I Zone 2 Group IIC certified 

Table 10-4 TC-FIDA81 - 120 Vac Digital Input

Parameter	Specification
Number of Inputs	8 (1 group of 8), non-isolated
ON-State Voltage	65V ac minimum
ON-State Current <i>AC inputs compatible with proximity switches with leakage ratings of I leak < 2.5mA and I on maximum = 5mA.</i>	7.1mA minimum
OFF-State Voltage	43V ac maximum
Maximum OFF-State Current	2.9mA
Nominal Input Impedance	10.6K Ω
Nominal Input Current	12mA @ 120V ac, 60Hz
Isolation Voltage: Channel to channel Customer power to input channels User to system	None None 100% tested at 2150V dc for 1s
Maximum Input Filter Time OFF to ON <i>(time from a valid input signal to recognition by module)</i> ON to OFF <i>(time from input dropping below valid level to recognition by module)</i>	8.4ms, 8.6ms, 9ms, 10ms, 12ms, 16ms, 24ms, and 40ms 26.4ms, 26.6ms, 27ms, 28ms, 30ms, 34ms, 42ms, and 58ms Filter time selectable through output image table. Default is 8.4ms off to on/26.4 on to off
Flexbus Current (max)	30mA @ 5V dc
Power Dissipation	Maximum 4.5W @ 132V ac
Thermal Dissipation	Maximum 15.3 BTU/hr @ 132V ac
Indicators (field side indication, customer device driven)	8 yellow status indicators
Keyswitch Position	8
General Specifications	
External AC Power Supply Voltage Voltage Range	120V ac nominal 85 to 132V ac, 47-63Hz
Dimensions HxWxD	46mm x 94mm x 53mm (1.8in x 3.7in x 2.1in)
Environmental Conditions: Operational Temperature Storage Temperature Relative Humidity Shock : Operating Shock: Non-operating Vibration	0 to 55°C (32 to 131°F) -40 to 85°C (-40 to 185°F) 5 to 95% non-condensing 30g peak acceleration, 11(±1)ms pulse width 50g peak acceleration, 11(±1)ms pulse width Tested 5g @ 10-500Hz per IEC 68-2-6
Conductors Wire Size	12 gauge (4mm ²) stranded maximum 3/64 inch (1.2mm) insulation maximum
Agency Certification	  Groups A, B, C, D certified Class I Division 2 certified Class I Zone 2 Group IIC certified 

Table 10-5 TC-FIAH81 - High Level Analog Input

Parameter	Specification
Number of Inputs	8 single-ended, non-isolated
Input Current Terminal	4-20mA (user configurable); 0-20mA (user configurable)
Input Voltage Terminal	±10V (user configurable); 0-10V (user configurable)
Resolution: Voltage Current	12 bits - unipolar; 11 bits plus sign - bipolar 2.56mV/cnt unipolar; 5.13mV/cnt bipolar 5.13µA/cnt
Input Impedance: Voltage Terminal Current Terminal	100k Ω 238 Ω
Input Resistance: Voltage Terminal Current Terminal	200k Ω 238 Ω
Isolation Voltage	Tested at 850V dc for 1s between user and system No isolation between individual channels
Flexbus Current	20mA @ 5V dc
Power Dissipation	3W maximum @ 31.2V dc
Thermal Dissipation	Maximum 10.2 BTU/hr @ 31.2V dc
Indicators	1 green power indicator
Keyswitch Position	3
Data Format	Left justified 16-bit 2's complement
Conversion Type	Successive approximation
Conversion Rate	256µs all channels
Normal Mode Rejection Ratio Voltage Terminal Current Terminal	-3db @ 17Hz; -20db/decade -10.0dB @ 50Hz, -11.4dB @ 60Hz -3db @ 9Hz; -20db/decade -15.3dB @ 50Hz, -16.8dB @ 60Hz
Calibration	None Required
Step Response to 63% Voltage Terminal Current Terminal	9.4ms 18.2ms
Absolute Accuracy Voltage Terminal Current Terminal	0.20% Full Scale @ 25°C 0.20% Full Scale @ 25°C <i>Includes offset, gain, non-linearity and repeatability error terms.</i>
Accuracy Drift w/Temperature: Voltage Terminal Current Terminal	0.00428% Full Scale/°C 0.00407% Full Scale/°C
Maximum Overload	30V or 32mA continuous, 1 channel at a time
Dimensions HxWxD	46mm x 94mm x 53mm (1.8in x 3.7in x 2.1in)
Environmental Conditions: Operational Temperature Storage Temperature	0 to 55°C (32 to 131°F) -40 to 85°C (-40 to 185°F)







Relative Humidity Shock: Operating Shock: Non-operating Vibration	5 to 95% non-condensing (operating) 5 to 80% non-condensing (non-operating) 30g peak acceleration, 11(±1)ms pulse width 50g peak acceleration, 11(±1)ms pulse width Tested 5g @ 10-500Hz per IEC 68-2-6
Conductors Wire Size	12 gauge (4mm ²) stranded maximum 3/64 inch (1.2mm) insulation maximum
Agency Certification	  Groups A, B, C, D certified Class I Division 2 certified Class I Zone 2 Group IIC certified 

Table 10-6 TC-FIA121 - High Level Analog Input

Parameter	Specification
Number of Inputs	12 single-ended, non-isolated
Input Current Terminal	4-20mA (user configurable); 0-20mA (user configurable)
Input Voltage Terminal	±10V (user configurable); 0-10V (user configurable)
Resolution: Voltage Current	16 bits – 2's complement 320µV/cnt 0.641µA/cnt
Input Impedance: Voltage Terminal Current Terminal	Greater than 1 megohm Less than 100 ohms
Isolation Voltage	50V continuous Tested at 850V dc for 60s between user and system No isolation between individual channels
Flexbus Current	80mA @ 5V dc
Power Dissipation	1.2 W maximum @ 31.2V dc
Thermal Dissipation	Maximum 4.1 BTU/hr @ 31.2V dc
Indicators	1 green/red power/status indicator
Data Format	16-bit 2's complement
Keyswitch Position	3
Conversion Type	Successive approximation
Conversion Rate	8.0 ms all channels
Normal Mode Rejection Ratio Voltage/Current Terminal Voltage/Current Terminal with Quick Step	-3db @ 0.05Hz; -20db/decade -52dB @ 50Hz, -54dB @ 60Hz -3db @ 1.5Hz; -20db/decade -29dB @ 50Hz, -31dB @ 60Hz
Calibration	None Required
Step Response to 63% Voltage/Current Terminal Voltage/Current Terminal with Quick Step	1.3 s 0.09 s

Absolute Accuracy Voltage Terminal Current Terminal	0.10% Full Scale @ 25°C 0.10% Full Scale @ 25°C
Accuracy Drift w/Temperature: Voltage Terminal Current Terminal	0.004% Full Scale/°C 0.004% Full Scale/°C
Maximum Overload	30V or 32mA continuous, 1 channel at a time
Dimensions HxWxD	94mm x 94mm x 53.3mm (3.7in x 3.7in x 2.1in)
Environmental Conditions: Operational Temperature Storage Temperature Relative Humidity Shock: Operating Shock: Non-operating Vibration	-20 to 60°C (-4 to 140°F) -40 to 85°C (-40 to 185°F) 5 to 95% non-condensing (operating) 30g 50g 5g @ 10-500Hz
Conductors Wire Size	12 gauge (4mm ²) stranded maximum 3/64 inch (1.2mm) insulation maximum
Agency Certification	 cULus Groups A, B, C, D certified Class I Division 2 certified Class I Zone 2 Group IIC certified  (C-Tick) 

email: sales@cambridge

Table 10-7 TC-FID161 - 24 Vdc Sink Digital Input



Parameter	Specification
Number of Channels	16 (1 group of 16, non-isolated, sinking)
Module Location	DIN-rail mounted
Module Type	16 digital input - sinking
ON-State Voltage	10V dc minimum; 24V dc nominal 31.2V dc maximum
ON-State Current	2mA minimum; 8.8mA nominal at 24V dc 12.1mA maximum
OFF-State Voltage	5.0V dc maximum
OFF-State Current	1.5mA minimum
Input Impedance	2.5K Ω
Dielectric Withstand Test	100% tested at 1900V dc for 1s between user and system No isolation between individual channels
Maximum Input Filter Times (Selectable) OFF to ON ON to OFF	256 μ s, 512 μ s, 1ms, 2ms, 4ms, 8ms, 16ms, 32ms 256 μ s, 512 μ s, 1ms, 2ms, 4ms, 8ms, 16ms, 32ms 256 μ s default - selectable thru output image table (see Setting Input Filter Times)
Flexbus Current	25mA maximum
Power Dissipation	6.1W @ 31.2V dc
Thermal Dissipation	20.8 BTU/hr @ 31.2V dc
Indicators	16 yellow channel status indicators
General Specifications	
External dc Power Voltage	19.2-31.2V dc (5% ac ripple)
Dimensions	HxWxD 69mm x 94mm x 80mm (2.72in x 3.7in x 3.2in)
Environmental Conditions Operational Temperature Storage Temperature Relative Humidity Shock: Operating Shock: Non-operating Vibration	0 to 55°C (32 to 131°F) -40 to 85°C (-40 to 185°F) 5 to 95% non-condensing 30g peak acceleration, 11(\pm 1)ms pulse width 50g peak acceleration, 11(\pm 1)ms pulse width Tested 5g @ 10-500Hz per IEC 68-2-6
Conductors Wire Size	12 gauge (4mm ²) stranded maximum 3/64 inch (1.2mm) maximum insulation, 90C minimum temperature rating
Terminal Screw Torque	4-7 inch-pounds
Agency Certification	  Groups A, B, C, D certified Class I Division 2 certified Class I Zone 2 Group IIC certified 

Table 10-8 TC-FID321 - 24 Vdc Sink Digital Input



Parameter	Specification
Number of Channels	32 (2 group of 16) non-isolated within groups
Module Location	DIN-rail mounted
Module Type	32 digital input - sinking
ON-State Voltage	19.2Vdc minimum 24Vdc nominal 31.2Vdc maximum
ON-State Current	2mA minimum; 4.1mA nominal at 24V dc 6.0mA maximum
OFF-State Voltage	5.0V dc maximum
OFF-State Current	1.5mA minimum
Input Impedance	6.0K Ω
Isolation Voltage	Tested at 2121Vdc for 2s between user and system No isolation between individual channels
Maximum Input Filter Times (Selectable) OFF to ON	0.25ms, 0.5ms, 1ms, 2ms, 4ms, 8ms, 16ms, 32ms
ON to OFF	0.25ms, 0.5ms, 1ms, 2ms, 4ms, 8ms, 16ms, 32ms 0.25ms default
Flexbus Current	25mA @ 5Vdc
Power Dissipation	6.0W @ 31.2V dc
Thermal Dissipation	20.5 BTU/hr @ 31.2V dc
Indicators	32 yellow channel status indicators
General Specifications	
External dc Power Voltage	19.2 - 31.2Vdc (includes 5% ac ripple)
Dimensions	HxWxD 94mm x 94mm x 69mm (3.7in x 3.7in x 2.7in)
Environmental Conditions Operational Temperature Storage Temperature Relative Humidity Shock: Operating Shock: Non-operating Vibration	0 to 55°C (32 to 131°F) -40 to 85°C (-40 to 185°F) 5 to 95% non-condensing 30g 50g Tested 5g @ 10-500Hz per IEC 68-2-6
Conductors Wire Size	12 gauge (4mm ²) stranded maximum 3/64 inch (1.2mm) maximum insulation, 75C or higher temperature rating
Terminal Screw Torque	4-7 inch-pounds
Agency Certification	 cULus Groups A, B, C, D certified Class I Division 2 certified Class I Zone 2 Group IIC certified 

Table 10-9 TC-FIR081 - 3-wire RTD Analog Input

Parameter	Specification
Number of Inputs	8 Channels
Signal Input Range	1 to 433 Ω
Sensors Supported	Resistance: 100 Ω Pt μ = 0.00385 Euro (-200 to +870°C) 100 Ω Pt μ = 0.003916 U.S. (-200 to +630°C) 200 Ω Pt μ = 0.00385 Euro (-200 to +630°C) 500 Ω Pt μ = 0.00385 Euro (-200 to +630°C) 100 Ω Nickel μ = 0.00618 (-60 to +250°C) 120 Ω Nickel μ = 0.00672 (-60 to +250°C) 200 Ω Nickel μ = 0.00618 (-60 to +250°C) 500 Ω Nickel μ = 0.00618 (-60 to +250°C) 10 Ω Copper α = 0.00427 (-200 to +260°C)
Resolution	16 bits across 435 Ω
Data Format	Left justified 16-bit 2's complement or offset binary
Normal Mode Noise Rejection	60db @ 60Hz for A/D filter cutoff @ 15Hz
Accuracy without Calibration (low humidity)	Normal mode: 0.05% Full Scale (maximum) Enhanced Mode: 0.01% Full Scale (typical)
Common Mode Rejection	-120db @ 60Hz; -100db @ 50Hz with A/D filter cutoff @ 10Hz
Common Mode Voltage	0V between channels (common return)
System Throughput Normal mode: Enhanced mode:	Programmable from 28ms/channel to 325ms/channel 325ms (1 channel scanned) 2.6s (8 channels scanned) Programmable from 56ms/channel to 650ms/channel 650ms (1 channel scanned) 2.925s (8 channels scanned)
Settling Time to 100% of Final Value	Available at system throughput rate
Open RTD Detection	Out of range reading (upscale)
Open Wire Detection Time	Available at system throughput rate
Overvoltage Capability	35V dc, 25V ac continuous @ 25°C 250V peak transient
Channel Bandwidth	dc to 2.62Hz (-3db)
RFI Immunity	Error of less than 1% of range at 10V/M 27 to 1000MHz
Input Offset Drift with Temperature	1.5 m Ω /C° maximum
Gain Drift with Temperature	Normal mode: 20 ppm/°C maximum Enhanced mode: 10 ppm/°C maximum
RTD Excitation Current	718.39 μ A
Indicators	1 red/green status indicator
Flexbus Current	20mA



Power Dissipation	3W maximum @ 31.2V dc
Thermal Dissipation	Maximum 10.2 BTU/hr @ 31.2V dc
Keyswitch Position	3
Cable Requirements	2-wire Belden 9501 3-wire, less than 100ft (30.5m) with normal humidity- Belden 9533 3-wire, greater than 100ft (30.5m) or high humidity (>55% for >8 hrs) - Belden 83503
General Specifications	
External dc Power Supply Voltage Voltage Range Supply Current	24V dc nominal 19.2 to 31.2V dc (includes 5% ac ripple) 19.2V dc for ambient temperatures < 55°C 24V dc for ambient temperatures < 55°C 31.2V dc for ambient temperatures < 40°C 140mA @ 24V dc
Dimensions HxWxD	46mm x 94mm x 53mm (1.8in x 3.7in x 2.1in)
Environmental Conditions Operational Temperature Storage Temperature Relative Humidity Shock: Operating Shock: Non-operating Vibration	0 to 55°C (32 to 131°F) -40 to 85°C (-40 to 185°F) 5 to 95% non-condensing (operating) 5 to 80% non-condensing (non-operating) 30g peak acceleration, 11(±1)ms pulse width 50g peak acceleration, 11(±1)ms pulse width Tested 5g @ 10-500Hz per IEC 68-2-6
Agency Certification	  Groups A, B, C, D certified Class I Division 2 certified Class I Zone 2 Group IIC certified 

Table 10-10 TC-FIL081 - Thermocouple Analog Input

Parameter	Specification
Number of Inputs	8 Channels
Nominal Input Voltage Ranges	±76.5mV
Supported Thermocouple Types	Type B: 300 to °C (572 to 3272°F) Type C: 0 to 2315 °C (32 to 4199°F) Type E: -270 to 1000 °C (-454 to 1832°F) Type J: -210 to 1200 °C (-346 to 2192°F) Type K: -270 to 1372 °C (-454 to 2502°F) Type N: -270 to 1300 °C (-454 to 2372°F) Type R: -50 to 1768 °C (-58 to 3214°F) Type S: -50 to 1768 °C (-58 to 3214°F) Type T: -270 to 400 °C (-454 to 752°F) Type TXK/XK (L): -200 to 800 °C (-328 to 1472°F)
Resolution	16 bits (2.384 µV typical)
Accuracy with filter @ 24 °C (±0.5°C)	0.025% Full Scale Range maximum (±0.5°C) ¹
Accuracy without filter @ 24 °C (±0.5°C)	0.05% Full Scale Range maximum (±0.5°C) ¹
Data Format	16-bit 2's complement or offset binary (unipolar)
Normal Mode Noise Rejection	-60db @ 60Hz
Common Mode Rejection	-115db @ 60Hz; -100db @ 50Hz
Common Mode Input Range	+10V maximum
Channel to Channel Isolation	±10V
System Throughput	325ms (1 channel scanned), programmable to 28ms 2.6s (8 channels scanned), programmable to 224ms
Settling Time to 100% of final value	Available at system throughput rate
Open Circuit Detection	Out of range reading (upscale)
Open Thermocouple Detection Time	Available at system throughput rate
Overvoltage Capability	35V dc, 25V ac continuous @ 25°C 250V peak transient
Channel Bandwidth	0 to 2.62Hz (-3db)
RFI Immunity	Error of less than 1% of range at 10V/M 27 to 1000MHz
Input Offset Drift With Temperature	+6 µV/°C maximum
Gain Drift With Temperature	10ppm/°C maximum
Overall Drift With Temperature	50ppm/°C of span (maximum)
Cold Junction Compensation Range	0 to 70 °C
Indicators	1 red/green power/status indicator
Flexbus Current	20mA
Power Dissipation	3W maximum @ 31.2V dc
Thermal Dissipation Maximum	10.2 BTU/hr @ 31.2V dc
Keyswitch Position	3

(Important Operational Note) To obtain the stated accuracy, the lead wire resistance must be compensated for as part of the calibration procedure. The test source standard must be connected at the far end point of the lead wire so the resistance can be accounted for as part of the calibration. To perform a calibration procedure the module must be taken off-line. All eight channels will be inactive and unusable for control for the duration calibration procedure.

General Specifications



External dc Power Supply Voltage Voltage Range	24V dc nominal 19.2 to 31.2V dc (includes 5% ac ripple) 19.2V dc for ambient temperatures < 55 °C 24V dc for ambient temperatures < 55 °C 31.2V dc for ambient temperatures < 40 °C
Supply Current	150mA @ 24V dc
Dimensions HxWxD	1.8mm x 3.7mm x 2.1mm (46in x 94in x 53in)
Environmental Conditions Operational Temperature Storage Temperature Relative Humidity	0 to 55 °C (32 to 131 °F) See derating curve. -40 to 85 °C (-40 to 185 °F) 5 to 95% non-condensing (operating) 5 to 80% non-condensing (non-operating)
Shock: Operating Shock: Non-operating Vibration	30 g peak acceleration, 11(±1)ms pulse width 50 g peak acceleration, 11(±1)ms pulse width Tested 5 g @ 10-500Hz per IEC 68-2-6
Agency Certification	  Groups A, B, C, D certified Class I Division 2 certified Class I Zone 2 Group IIC certified 

Table 10-11 TC-FODA81 - 120 Vac Digital Output



Parameter	Specification
Number of Outputs	8 (1 group of 8), non-isolated
Maximum On-State Voltage Drop	1.0V @ 0.5A
ON-State Current	5mA per output minimum 500mA per output maximum @ 55°C (sufficient to operate an A-B Bulletin 500 NEMA size 3 motor starter); 750mA per output maximum @ 35°C; 1.0A maximum on 4 adjacent outputs, 500mA on the remaining 4 Outputs @ 30°C
OFF-State Leakage	2.25mA maximum
Output Voltage Range	85-132V ac, 47-63Hz
Output Current Rating	4.0A (8 outputs @ 500mA)
Isolation Voltage	1250V ac between user and system No isolation between individual channels; No isolation between customer power and output channels
Output Signal Delay: OFF to ON ON to OFF	1/2 cycle maximum 1/2 cycle maximum
Flexbus Current (max)	80mA
Power Dissipation	4.1W max @ 0.5A; 6.3W max @ 0.75A 6.3W max @ 1.0A
Thermal Dissipation	21.4 BTU/hr @ 1.0A
Indicators (field side indication, logic driven)	8 yellow status indicators
Keyswitch Position	8
Surge Current	7A for 45ms, repeatable every 8 seconds
Fusing	Use 1.6A, 250V ac Slow-Blow, Littelfuse pt. no. 23901.6; San-O SD6-1.6A
General Specifications	
External ac Power: Supply Voltage Input Frequency Voltage Range Surge Current Capability	120V ac nominal 47-63Hz 85 to 132V ac Maximum 50A for 1/2 cycle at powerup
Dimensions HxWxD	46mm x 94mm x 53mm (1.8in x 3.7in x 2.1in)
Environmental Conditions: Operational Temperature Storage Temperature Relative Humidity Shock: Operating Shock: Non-operating Vibration	0 to 55°C (32 to 131°F) -40 to 85°C (-40 to 185°F) 5 to 95% non-condensing 30g peak acceleration, 11(±1)ms pulse width 50g peak acceleration, 11(±1)ms pulse width Tested 5g @ 10-500Hz per IEC 68-2-6
Conductors Wire Size	12 gauge (4mm ²) stranded maximum 3/64 inch (1.2mm) insulation maximum
Agency Certification	  Groups A, B, C, D certified Class I Division 2 certified Class I Zone 2 Group IIC certified 

Table 10-12 TC-FOD161 - 24 Vdc Source Digital Output - Protected



Parameter	Specification
Number of Channels	16 (1 group of 16, non-isolated)
Module Location	DIN-rail mounted
ON-State Voltage	10V dc minimum 24V dc nominal 31.2V dc maximum
ON-State Current	1mA minimum per channel 500mA maximum per channel
OFF-State Voltage Drop	0.5V dc maximum
OFF-State Leakage	0.5mA maximum leakage
Surge Current	1.5A for 50ms, repeatable every 2s
Dielectric Withstand Test	100% tested at 850V dc for 1s between user and system No isolation between individual channels
Maximum Input Delay Times: OFF to ON ON to OFF	0.5ms maximum 1.0ms maximum
Flexbus Current	80mA maximum
Power Dissipation	5W @ 31.2V dc
Thermal Dissipation	17 BTU/hr @ 31.2V dc
Indicators	16 yellow channel status indicators
General Specifications	
External dc Power Voltage Current	19.2-31.2V dc (5% ac ripple) 80mA
Dimensions HxWxD	69mm x 94mm x 80mm (2.72in x 3.7in x 3.20in)
Environmental Conditions: Operational Temperature Storage Temperature Relative Humidity Shock: Operating Shock: Non-operating Vibration	0 to 55°C (32 to 131°F) -40 to 85°C (-40 to 185°F) 5 to 95% non-condensing 30g peak acceleration, 11(±1)ms pulse width 50g peak acceleration, 11(±1)ms pulse width Tested 5g @ 10-500Hz per IEC 68-2-6
Conductors Wire Size	12 gauge (4mm ²) stranded maximum 3/64 inch (1.2mm) maximum insulation, 90C minimum temperature rating
Terminal Screw Torque	4-7 inch-pounds
Agency Certification	  Groups A, B, C, D certified Class I Division 2 certified Class I Zone 2 Group IIC certified 

Table 10-13 TC-FOD321 - 24 Vdc Source Digital Output - Protected



Parameter	Specification
Number of Channels	32 (2 group of 16), non-isolated within groups
Module Location	DIN-rail mounted
Module Type	32 digital output - sourcing
Output Current Rating	14A maximum per channel (6A total for channels 0-15, 8A total for channels 16-31)
ON State Voltage Range	10Vdc minimum 24Vdc nominal 31,2Vdc maximum
ON-State Current	1mA minimum per channel 500mA maximum per channel
ON-State Voltage Drop	0.5V dc maximum
OFF-State Leakage	0.5mA maximum leakage
Surge Current	2A for 50ms, repeatable every 2s
Isolation Voltage	Tested at 2121V dc for 1s between user and system No isolation between individual channels
Maximum Input Delay Times: OFF to ON ON to OFF	0.5ms maximum 1.0ms maximum
Flexbus Current	80mA maximum
Power Dissipation	5.3W @ 31.2V dc
Thermal Dissipation	18.1 BTU/hr @ 31.2V dc
Indicators	32 yellow channel status indicators
General Specifications	
External dc Power Voltage Current	10 - 31.2Vdc (5% ac ripple) 219mA @ 24Vdc, (104mA @ 10Vdc, 278mA @ 31.2Vdc)
Dimensions HxWxD	94mm x 94mm x 69mm (3.7in x 3.7in x 2.7in)
Environmental Conditions: Operational Temperature Storage Temperature Relative Humidity Shock: Operating Shock: Non-operating Vibration	0 to 55°C (32 to 131°F) -40 to 85°C (-40 to 185°F) 5 to 95% non-condensing 30g 50g Tested 5g @ 10-500Hz per IEC 68-2-6
Conductors Wire Size	12 gauge (4mm ²) stranded maximum 3/64 inch (1.2mm) maximum insulation, 75C or higher temperature rating
Agency Certification	 cULus Groups A, B, C, D certified Class I Division 2 certified Class I Zone 2 Group IIC certified 

Table 10-14 TC-FOA041 - Analog Output

Parameter	Specification
Number of Outputs	4 single-ended, non-isolated
Resolution	12 bits plus sign
Voltage	2.56mV/cnt
Current	5.13 μ A/cnt
Data Format	Left justified 16-bit 2's complement
Conversion Type	Pulse Width Modulation
Conversion Rate	1.024ms maximum all channels
Output Current Terminal	0mA output until module is configured 4-20mA user configurable 0-20mA user configurable
Output Voltage Terminal	0V output until module is configured \pm 10V user configurable 0-10V user configurable
Step Response to 63% of FS	24ms
Current Load on Voltage Output	Maximum 3mA
Resistive Load on mA Output	15 - 750 Ω
Absolute Accuracy Voltage Terminal Current Terminal <i>Includes offset, gain, non-linearity and repeatability error terms.</i>	0.133% Full Scale @ 25°C 0.425% Full Scale @ 25°C
Accuracy Drift with Temperature Voltage Terminal Current Terminal	0.0045% Full Scale/°C 0.0069% Full Scale/°C
Calibration	None required
Isolation Voltage	Tested at 850V dc for 1s between user and system No isolation between individual channels
Indicators	1 green power indicator
Flexbus Current	20mA @ 5V dc
Power Dissipation	Maximum 4.5W @ 31.2V dc
Thermal Dissipation	Maximum 15.3 BTU/hr @ 31.2V dc
Keyswitch Position	4
General Specifications	
External dc Power Supply Voltage Voltage Range Supply Current	24V dc nominal 19.2 to 31.2V dc (includes 5% ac ripple) 70mA @ 24V dc (not including outputs)
Dimensions (HxWxD)	46mm x 94mm x 53mm (1.8in x 3.7in x 2.1in)



Environmental Conditions: Operational Temperature Storage Temperature Relative Humidity Shock: Operating Shock: Non-operating Vibration	0 to 55°C (32 to 131°F) -40 to 85°C (-40 to 185°F) 5 to 95% non-condensing (operating) 5 to 80% non-condensing (non-operating) 30g peak acceleration, 11(±1)ms pulse width 50g peak acceleration, 11(±1)ms pulse width Tested 5g @ 10-500Hz per IEC 68-2-6
Conductors Wire Size	12 gauge (4mm ²) stranded maximum 3/64 inch (1.2mm) insulation maximum
Agency Certification	  Groups A, B, C, D certified Class I Division 2 certified Class I Zone 2 Group IIC certified 

Table 10-15 TC-FOA121 - Analog Output

Parameter	Specification
Number of Outputs	12 single-ended, non-isolated
Resolution	16 bits
Voltage	320µV/cnt
Current	0.641µA/cnt
Data Format	16-bit 2's complement
Conversion Type	Digital to Analog Converter
Conversion Rate	1.024ms maximum all channels
Output Current Terminal	0mA output until module is configured 4-20mA user configurable 0-20mA user configurable
Output Voltage Terminal	0V output until module is configured ±10V user configurable
Step Response	70% 1 st convert, 96% 2 nd convert, 100% 3 rd convert
Current Load on Voltage Output	Maximum 3mA
Resistive Load on mA Output	0 - 750 Ω
Absolute Accuracy Voltage Terminal Current Terminal <i>Includes offset, gain, non-linearity and repeatability error terms.</i>	0.1% Full Scale @ 25°C 0.1% Full Scale @ 25°C
Accuracy Drift with Temperature Voltage Terminal Current Terminal	0.004% Full Scale/°C 0.004% Full Scale/°C
Calibration	None required
Isolation Voltage	50V continuous Tested at 850V dc for 60s between user and system No isolation between individual channels





Indicators	1 green/red power/status indicator
Flexbus Current	80mA @ 5V dc
Power Dissipation	Maximum 4.0W @ 31.2V dc
Thermal Dissipation	Maximum 14.7 BTU/hr @ 24V dc
Keyswitch Position	4
General Specifications	
External dc Power Supply Voltage Voltage Range Supply Current	24V dc nominal 10.0 to 31.2V dc (includes 5% ac ripple) 320mA @ 24V dc
Dimensions (HxWxD)	94mm x 94mm x 53mm (3.7in x 3.7in x 2.1in)
Environmental Conditions: Operational Temperature Storage Temperature Relative Humidity Shock: Operating Shock: Non-operating Vibration	-20 to 60°C (-4 to 140°F) -40 to 85°C (-40 to 185°F) 5 to 95% non-condensing (non-operating) 30g 50g Tested 5g @ 10-500Hz per IEC 68-2-6
Conductors Wire Size	12 gauge (4mm ²) stranded maximum 3/64 inch (1.2mm) insulation maximum
Agency Certification	 <ul style="list-style-type: none"> cULus Groups A, B, C, D certified Class I Division 2 certified Class I Zone 2 Group IIC certified 

Table 10-16 TC-FOR081 - Relay Digital Output

Parameter	Specification
Outputs per Module	8 Form A isolated (normally open) electromechanical relays
Off-State Leakage Current (max at 240V ac)	1mA through snubber circuit
Output Voltage Range (load dependent)	5-30V dc @ 2.0A resistive 48V dc @ 0.5A resistive 125V dc @ 0.25A resistive 125V ac @ 2.0A resistive 240V ac @ 2.0A resistive
Output Current Rating (at rated power)	Resistive 2A @ 5-30V dc 0.5A @ 48V dc 0.25A @ 125V dc 2A @ 125V ac 2A @ 240V ac Inductive 2.0A steady state @ 5-30V dc, L/R = 7ms 0.5A steady state @ 48V dc, L/R = 7ms 0.25A steady state @ 125V dc, L/R = 7ms 2.0A steady state, 15A make @ 125V ac, PF = cos ϕ = 0.4 2.0A steady state, 15A make @ 240V ac, PF = cos ϕ = 0.4
Power Rating (steady state)	250W max. for 125V ac resistive output 480W max. for 240V ac resistive output 60W max. for 30V dc resistive output 24W max. for 48V dc resistive output 31W max. for 125V dc resistive output 250VA max. for 125V ac inductive output 480VA max. for 240V ac inductive output 60VA max. for 30V dc inductive output 24VA max. for 48V dc inductive output 31VA max. for 125V dc inductive output
Isolation Voltage Between any 2 sets of contacts Customer load to logic Customer load to 24V dc supply Customer 24V dc supply to logic	2550V dc for 1s 2550V dc for 1s 2550V dc for 1s 850V dc for 1s
Output Signal Delay OFF to ON ON to OFF	8ms maximum (time from valid output on signal to relay energization by module) 26ms maximum (time from valid output off signal to relay deenergization by module)
Flexbus Current (max)	69mA @ 5V dc
Power Dissipation	Maximum 5.5W
Thermal Dissipation	Maximum 18.8 BTU/hr



Indicators (field side indication, logic driven)	8 yellow status indicators
Keyswitch position	9
Initial Contact Resistance	30mW
Switching Frequency	1 operation/3s (0.3Hz at rated load) max
Operate/Release Time	Maximum 10ms
Bounce Time	1.2ms (mean)
Minimum Contact Load	100µA at 100mV dc
Expected Life of Electrical Contacts	Minimum 100,000 operations @ rated loads
Fusing <i>Module outputs are not fused. If external fusing is desired, you must provide external fusing</i>	Use a fused terminal base with a 3.0A Littelfuse 239003
Max Inrush Current	15A
General Specifications	
External dc Power Supply Voltage Voltage Range Supply Current	24V dc nominal 19.2 to 31.2V dc (includes 5% ac ripple) 125mA maximum
Dimensions HxWxD	46mm x 94mm x 53mm (1.8in x 3.7in x 2.1in)
Environmental Conditions: Operational Temperature Storage Temperature Relative Humidity Shock: Operating Shock: Non-operating Vibration	0 to 55°C (32 to 131°F) -40 to 85°C (-40 to 185°F) 5 to 95% non-condensing 12g peak acceleration, 11(±1)ms pulse width 50g peak acceleration, 11(±1)ms pulse width Tested 2g @ 10-500Hz per IEC 68-2-6
Conductors Wire Size	12 gauge (4mm ²) stranded maximum 3/64 inch (1.2mm) insulation maximum
Agency Certification	  Meets URLR150 and C300 Meets IEC 1131 AC-15 Utilization Category Groups A, B, C, D certified Class I Division 2 certified Class I Zone 2 Group IIC certified 

11. ControlNet Communications

11.1 Specifications

ControlNet Gateway Redundant Media: TC-PGCN11

Parameter	Description
General	
I/O Capacity	8 modules
Input Voltage Rating (+V, -V Intrinsicly Safe)	Intrinsicly Safe Power Supply Channel: $U_i \leq 9.5\text{Vdc}$ $I_i \leq 1\text{A}$ $L_i = \text{Negligible}$ $C_i \leq 120\text{nF}$
Power Consumption	One power supply unit load
Power Dissipation	8W
Internal Bus (Backplane)	Vendor-Specific Bus: $U_o \leq 5.4\text{Vdc}$ $I_o \leq 400\text{mA}$ $P_o \leq 2.16\text{W}$ $L_o \leq 10\mu\text{H}$ $C_o \leq 65\mu\text{F}$
External Bus (ControlNet A and B)	ControlNet International Version 1.5, Intrinsicly Safe: $U_o \leq 5.4\text{Vdc}$ $I_o \leq 160\text{mA}$ ac coupled with high pass filter $f \geq 500\text{kHz}$
Communication Rate	5M bit/s
Galvanic Isolation (Per DIN EN 50 020)	Backplane Bus / Power Supply Backplane Bus / ControlNet ControlNet / Power Supply
Operating Conditions	
Ambient Temperature	-20°C to 70°C (-4°F to 158°F or 253K to 343K)
Storage Temperature	-20°C to 100°C (-4°F to 212°F or 253K to 373K)
Maximum Relative Humidity	95%, non-condensing
Pollution Gas Test	Test Level G3, according to ISA-S71.04-1985
Shock Test	15g peak 11ms duration
Vibration Test	2g @ 10Hz to 500Hz, according to IEC 68-2-6
Protection Class	IP20 (For installation in the field, a separate housing with protection class IP54 or better is required.)
Physical	
Weight	0.347 kg (0.77 lb)
Dimensions (H x W x D)	Millimeters: 92 x 94 x 87 Inches: 3.6 x 3.7 x 3.4

Wire Size (Power Terminals)	12 AWG (4mm ²) stranded maximum 0.0469in (1.2mm) insulation maximum
ControlNet Cable	Belden 3092A (See ControlNet Specifications in Honeywell publication <i>Experion Controller Specification and Technical Data</i> for additional details.)
Standards	
Conformity to Standards	According to DIN EN 50014: 1992 According to DIN EN 50020: 1994Climatic Conditions according to DIN IEC 721 E.M. Compatibility according to DIN EN 50081-2, DIN EN 50082-2, NAMUR NE 21
CE Conformity (Europe)	To achieve EMC protection class, must mount in a cabinet with a copper seal and install ferrites on power supply and ControlNet Coax cables.
Classifications	CENELEC (Europe): II 2 G EEx ib IIC/IIB, T4
Agency Certification	 Marked for all applicable directives DMT 99 ATEX E 030 X 

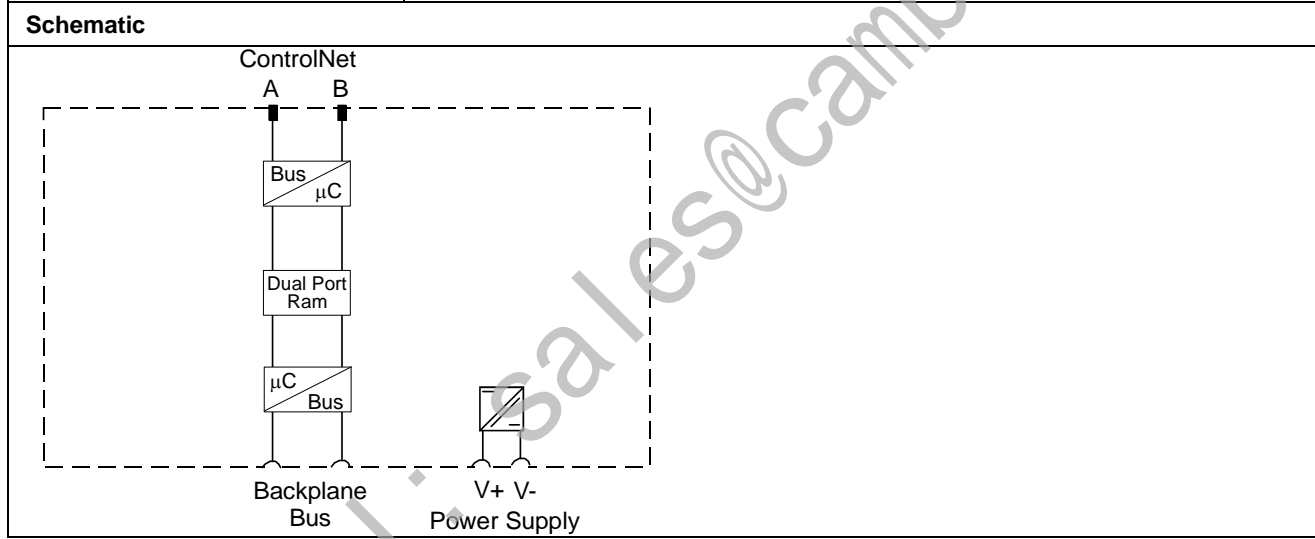

ControlNet Repeater Adapter: TC-PBFO01 (For Hazardous Locations)

Parameter	Description
General	
Fiber Module Capacity	2 Fiber Module modules
Input Voltage Rating (+V, -V Intrinsicly Safe)	Intrinsicly Safe Power Supply Channel: $U_i \leq 9.5V_{dc}$ $I_i \leq 1A$ $L_i = \text{Negligible}$ $C_i \leq 120nF$
Power Consumption	One power supply unit load
Power Dissipation	8W
Internal Bus (TTL)	Vendor-Specific Bus: $U_o \leq 5.4V_{dc}$ $I_o \leq 201mA$ $P_o \leq 1.09W$ $L_o \leq 0.45mH$ $C_o \leq 71\mu F$
External Bus	ControlNet International Version 1.5, Intrinsicly Safe: $U_o \leq 5.4V_{dc}$ $I_o \leq 201mA$ ac coupled with high pass filter $f \geq 900kHz$
Communication Rate	5M bit/s
Galvanic Isolation (Per DIN EN 50 020)	TTL Bus / Power Supply TTL Bus / ControlNet ControlNet / Power Supply
Operating Conditions	
Ambient Temperature	-20°C to 70°C (-4°F to 158°F or 253K to 343K)
Storage Temperature	-20°C to 100°C (-4°F to 212°F or 253K to 373K)
Maximum Relative Humidity	95%, non-condensing
Pollution Gas Test	Test Level G3, according to ISA-S71.04-1985
Shock Test	15g peak 11ms duration
Vibration Test	2g @ 10Hz to 500Hz, according to IEC 68-2-6
Protection Class	IP20 (For installation in the field, a separate housing with protection class IP54 or better is required.)
Physical	
Weight	0.319 kg (0.70 lb)
Dimensions (H x W x D)	Millimeters: 92 x 94 x 87 Inches: 3.6 x 3.7 x 3.4
Wire Size (Power Terminals)	12 AWG (4mm ²) stranded maximum 0.0469in (1.2mm) insulation maximum
ControlNet Cable	Belden 3092A (See ControlNet Specifications in Honeywell publication <i>Experion Controller Specification and Technical Data</i> for additional details.)
Standards	
Conformity to Standards	According to DIN EN 50014: 1992 According to DIN EN 50020: 1994 According to DIN EN 50284: 1997 Climatic Conditions according to DIN IEC 721 E.M. Compatibility according to DIN EN 50081-2, DIN EN 50082-2, NAMUR NE 21
CE Conformity (Europe)	TBD

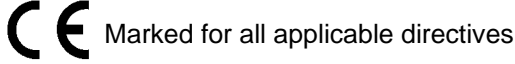
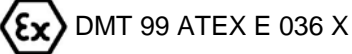
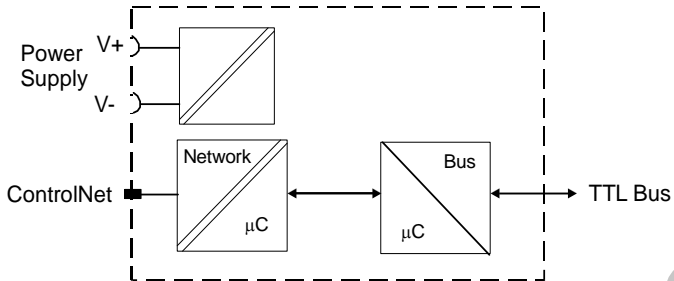
Classifications	CENELEC (Europe): II (1) 2G EEx ia/ib IIB/IIC T4
Agency Certification	 
Schematic	
 <p>The schematic diagram illustrates the internal connections of the device. It features a dashed rectangular boundary enclosing the main components. On the left, there are two terminals for 'Power Supply', labeled 'V+' and 'V-'. Below these is a 'ControlNet' terminal. Inside the dashed box, there are two microcontroller units (μC). The first μC is labeled 'Network' and is connected to the 'ControlNet' terminal. The second μC is labeled 'Bus' and is connected to the 'Network' μC via a bidirectional arrow. To the right of the 'Bus' μC, there is a bidirectional arrow connecting to a 'TTL Bus' terminal. A diagonal line is drawn through each μC symbol.</p>	



Email: sales@cambia.com

ControlNet Repeater Adapter: TC-RPA001 (For Non-Hazardous Locations)

Parameter	Description
General	
Fiber Capacity	2 Fiber modules
Input Voltage Rating (+V, -V)	20 to 35Vdc (24Vdc nominal)
Voltage Ripple	≤10%
Power Consumption	230 to 400mA
Power Dissipation	TBD
Internal Bus (TTL)	Vendor-Specific Bus:
External Bus	ControlNet International Version 1.5, Intrinsically Safe:
Communication Rate	5M bit/s
Galvanic Isolation (Per DIN EN 50 020)	TTL Bus / Power Supply TTL Bus / ControlNet ControlNet / Power Supply
Operating Conditions	
Ambient Temperature	-20°C to 70°C (-4°F to 158°F or 253K to 343K)
Storage Temperature	-20°C to 100°C (-4°F to 212°F or 253K to 373K)
Maximum Relative Humidity	95%, non-condensing
Shock Test	15g peak 11ms duration
Vibration Test	2g @ 10Hz to 500Hz, according to IEC 68-2-6
Physical	
Weight	0.226 kg (0.50 lb)
Dimensions (H x W x D)	Millimeters: 92 x 94 x 87 Inches: 3.6 x 3.7 x 3.4
Wire Size (Power Terminals)	12 AWG (4mm ²) stranded maximum 0.0469in (1.2mm) insulation maximum
ControlNet Cable	Belden 3092A (See ControlNet Specifications for additional details.)
Standards	
Conformity to Standards	Climatic Conditions according to DIN IEC 721
CE Conformity (Europe)	E.M. Compatibility according to DIN EN 50081-2, DIN EN 50082-2, NAMUR NE 21
Agency Certification	 Marked for all applicable directives
Schematic	
	

ControlNet Fiber Module: TC-PMFO01 (For Hazardous Locations)

Parameter	Description
General	
Fiber Module Capacity	1 Fiber Module plus 1 Repeater Adapter module
Input Voltage Rating	Power supplied through Repeater Adapter module
Power Consumption	Included with Repeater Adapter module
Power Dissipation	Included with Repeater Adapter module
Internal Bus (TTL)	Vendor-Specific Bus: Output 30-pin male Bus connector: $U_o \leq 5.4V_{dc}$ $I_o \leq 201mA$ $P_o \leq 1.09W$ $L_o \leq 0.45mH$ $C_o \leq 71\mu F$ Input 30-pin female Bus connector: $U_i \leq 5.4V_{dc}$ $I_i \leq 201mA$ $P_i \leq 1.09W$ $L_i \leq 15\mu H$ $C_i \leq 41\mu F$
Fiber Optic Type	62.5/125 micron
Fiber Optic Termination	ST (Plastic or Ceramic)
Fiber Optic Wavelength	1300nm
Fiber Optic Power Budget	13.3dB
Fiber Optic Transmission Distance	Up to 3KM (9,842ft)
Communication Rate	5M bit/s
Galvanic Isolation (Per DIN EN 50 020)	TTL Bus / ControlNet
Operating Conditions	
Ambient Temperature	-20°C to 70°C (-4°F to 158°F or 253K to 343K)
Storage Temperature	-20°C to 100°C (-4°F to 212°F or 253K to 373K)
Maximum Relative Humidity	95%, non-condensing
Pollution Gas Test	Test Level G3, according to ISA-S71.04-1985
Shock Test	15g peak 11ms duration
Vibration Test	2g @ 10Hz to 500Hz, according to IEC 68-2-6
Protection Class	IP20 (For installation in the field, a separate housing with protection class IP54 or better is required.)
Physical	
Weight	0.139 kg (0.31 lb)
Dimensions (H x W x D)	Millimeters: 94 x 94 x 87 Inches: 3.7 x 3.7 x 3.4
Standards	

Conformity to Standards	According to DIN EN 50014: 1992 According to DIN EN 50020: 1997 According to DIN EN 50284: 1997 Climatic Conditions according to DIN IEC 721
CE Conformity (Europe)	E.M. Compatibility according to DIN EN 50081-2, DIN EN 50082-2, NAMUR NE 21
Classifications	CENELEC (Europe): II (1) 2G EEx ia/ib IIB/IIC T4
Agency Certification	 Marked for all applicable directives  DMT 99 ATEX E 036 X

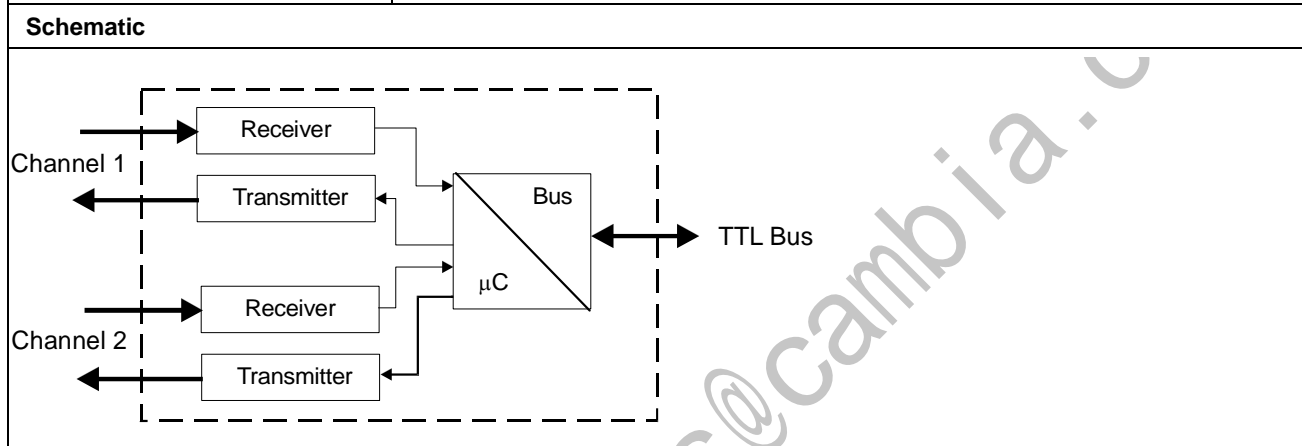

email: sales@cambia.com

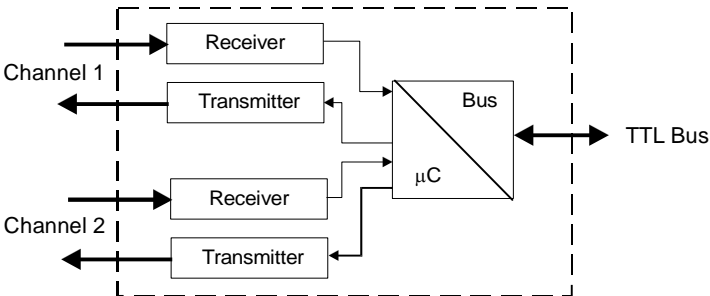

ControlNet Fiber Module: TC-RPFM01 (For Non-Hazardous Locations)

Parameter	Description
General	
Fiber Module Capacity	1 Fiber Module plus 1 Repeater Adapter module
Input Voltage Rating	Power supplied through Repeater Adapter module
Power Consumption	Included with Repeater Adapter module
Power Dissipation	Included with Repeater Adapter module
Internal Bus (TTL)	Vendor-Specific Bus: Output 30-pin male and Input 30-pin female Bus connectors
Fiber Optic Type	62.5/125 micron
Fiber Optic Termination	ST (Plastic or Ceramic)
Fiber Optic Wavelength	1300nm
Fiber Optic Power Budget	13.3dB
Fiber Optic Transmission Distance	Up to 3km (9,842ft)
Communication Rate	5M bit/s
Galvanic Isolation (Per DIN EN 50 020)	TTL Bus / ControlNet
Operating Conditions	
Ambient Temperature	-20°C to 70°C (-4°F to 158°F or 253K to 343K)
Storage Temperature	-20°C to 100°C (-4°F to 212°F or 253K to 373K)
Maximum Relative Humidity	95%, non-condensing
Shock Test	15g peak 11ms duration
Vibration Test	2g @ 10Hz to 500Hz, according to IEC 68-2-6
Physical	
Weight	0.147 kg (0.32 lb)
Dimensions (H x W x D)	Millimeters: 94 x 94 x 87 Inches: 3.7 x 3.7 x 3.4
Standards	
Conformity to Standards	Climatic Conditions according to DIN IEC 721
CE Conformity (Europe)	E.M. Compatibility according to DIN EN 50081-2, DIN EN 50082-2, NAMUR NE 21
Agency Certification	 Marked for all applicable directives
Schematic	
 <p>The schematic diagram illustrates the internal architecture of the fiber module. It features two communication channels, Channel 1 and Channel 2. Each channel consists of a Receiver and a Transmitter. The Receivers are connected to a central Bus, which is also connected to a microcontroller (µC). The Transmitters are connected to the Bus and the µC. The Bus is also connected to the TTL Bus. The entire module is enclosed in a dashed box.</p>	

Terminal Bases

Terminal Base with Screw Clamps: TC-PTBC11

Parameter	Description
General	
I/O Capacity	1 module per terminal base – mechanically keyed before wiring
Input Voltage Rating (+34, –35 Intrinsically Safe)	Intrinsically Safe Power Supply Channel: $U_i \leq 10\text{Vdc}$ $I_i \leq 2.5\text{A}$ $L_i = \text{Negligible}$ $C_i \leq 1\text{nF}$
Terminals	52 screw terminals: 1 row of 16 and 2 rows of 18
Terminal Assignments	Power Supply: +34, -35, +50, -51 (Use +50 and -51 to “daisy chain” power to another Terminal Base.) No Connection: 36, 49 – Make no connection to these terminals. Input/Output: Assignments made per I/O module – See individual I/O module specifications. $U_i \leq 30\text{Vdc}$ $I_i \leq 100\text{mA}$ $L_i = \text{Negligible}$ $C_i \leq 1\text{nF}$
Internal Bus (Backplane)	Vendor-Specific Bus – 16-pole plug SL2 and 16-pole socket BL2: $U_i \leq 10\text{Vdc}$ $I_i \leq 400\text{mA}$ $L_i = \text{Negligible}$ $C_i \leq 1\text{nF}$
Galvanic Isolation (Per DIN EN 50 020)	Backplane Bus / I/O Modules I/O Modules / Power Supply
Isolation Voltage	Determined by the I/O module used.
Operating Conditions	
Ambient Temperature	–20°C to 70°C (–4°F to 158°F or 253K to 343K)
Storage Temperature	–20°C to 100°C (–4°F to 212°F or 253K to 373K)
Maximum Relative Humidity	95%, non-condensing
Pollution Gas Test	Test Level G3, according to ISA-S71.04-1985
Shock Test	15g peak 11ms duration
Vibration Test	2g @ 10Hz to 500Hz, according to IEC 68-2-6
Protection Class	IP20 (For installation in the field, a separate housing with protection class IP54 or better is required.)
Physical	
Weight	0.228 kg (0.50 lb)
Dimensions (H x W x D)	Millimeters: 92 x 94 x 94 (With I/O module installed) Inches: 3.6 x 3.7 x 3.7
Wire Cross Section	0.2 to 2.5mm ² (0.0003 to 0.004in ²), with two cables maximum 2 x 1.5mm ² (0.002in ²) per terminal
Terminal Screws	M3, screwdriver 3.5mm (0.14in) x 0.5mm (0.02in)

Standards	
Conformity to Standards	According to DIN EN 50014: 1992 According to DIN EN 50020: 1997 According to DIN EN 50284: 1997 Climatic Conditions according to DIN IEC 721 E.M. Compatibility according to DIN EN 50081-2, DIN EN 50082-2, NAMUR NE 21
CE Conformity (Europe)	To achieve EMC protection class, must mount in a cabinet with a copper seal and install ferrites on power supply and ControlNet Coax cables.
Classifications	CENELEC (Europe): II 2G EEx ia IIC T4
Agency Certification	<div style="display: flex; flex-direction: column; align-items: flex-start;"> <div style="display: flex; align-items: center; margin-bottom: 20px;">  Marked for all applicable directives </div> <div style="display: flex; align-items: center;">  DMT 98 ATEX E 036 U </div> </div>

Email: sales@cambiaia.com



12. Input Modules

Analog Current Input Module (8-Points): TC-PIA081

Note: This module is withdrawn from sale, replaced by TC-PIA082

Parameter	Description
General	
Input Capacity	8 single-ended input channels referenced to a single common
Intrinsically Safe Input	Europe: II (1) 2G EEx ia/ib IIB/IIC T4 (CENELEC)
Input Type	2-Wire and 3-Wire transmitters
Input Functional Data	Input Range: Signal: 4 to 20mA Extended: 2 to 22mA Voltage: >15V @ 22mA
Accuracy	0.1% of signal range
Temperature Drift	50 ppm/°C
Response Time	4ms to 99% of final value
Resolution	16 Bits
Transmission Characteristics	Vendor Specific Bus – Intrinsically Safe Output Transmission Error @ 293K (20°C/68°F): 0.1% of output signal range Temperature Drift: 0.005%/K of output signal range
Permissible Field Circuit Values	2-Wire Input: Uo = 23.7V Io = 92.5mA Po = 548mW Lo : 10mH maximum for EEx ia IIB or EEx ib IIB 2.5mH maximum for EEx ia IIC or EEx ib IIC Co : 560nF maximum for EEx ia IIB or EEx ib IIB 66nF maximum for EEx ia IIC or EEx ib IIC 3-Wire Input: Uo = 23.7V Io = 93.5mA Po = 555mW Lo : 10mH maximum for EEx ia IIB or EEx ib IIB 2.5mH maximum for EEx ia IIC or EEx ib IIC Co : 560nF maximum for EEx ia IIB or EEx ib IIB 66nF maximum for EEx ia IIC or EEx ib IIC
Input Voltage Rating	Intrinsically Safe power supplied through Terminal Base
Power Consumption	0.95 power supply unit load
Power Dissipation	5.2W
Filter Cutoff	Configurable for input channel groups 0 to 3 and 4 to 7 -- 0.5, 1, 2, 4, 10 Hz..

Common Mode Rejection Ratio 50 to 60Hz	120dB
Circuit Fault	Lead Breakage: $I \leq 2\text{mA}$ Short Circuit: $V \leq 4\text{V}$
Lead Breakage Indication	Alarm signal through backplane Bus and channel LED flashing red for fault
Lead Breakage Indication Off (All Channels)	Configurable
Other Configurable Alarms	Overrange Alarm per channel Underrange Alarm per channel Transmitter Alarm per channel for defined fault current Transmitter Lead Breakage Alarm for transmitter open or short circuit, if supported by the transmitter
I/O Terminal Assignments	2-Wire Input: Ch0 – 0,1; Ch1 – 4,5; Ch2 – 8,9; Ch3 – 12,13; Ch4 – 17,18; Ch5 – 21,22; Ch6 – 25,26; Ch7 – 29,30 3-Wire Input: Ch0 – 0,1,2; Ch1 – 4,5,6; Ch2 – 8,9,10; Ch3 – 12,13,14; Ch4 – 17,18,19; Ch5 – 21,22,23; Ch6 – 25,26,27; Ch7 – 29,30,31
Galvanic Isolation (Per DIN EN 50 020)	Input / Backplane Bus Input / Power Supply (There is no galvanic isolation for the inputs relative to each other.)
Operating Conditions	
Ambient Temperature	–20°C to 70°C (–4°F to 158°F or 253K to 343K)
Storage Temperature	–20°C to 100°C (–4°F to 212°F or 253K to 373K)
Maximum Relative Humidity	95%, non-condensing
Pollution Gas Test	Test Level G3, according to ISA-S71.04-1985
Shock Test	15g peak 11ms duration
Vibration Test	2g @ 10Hz to 500Hz, according to IEC 68-2-6
Protection Class	IP20 (For installation in the field, a separate housing with protection class IP54 or better is required.)
Physical	
Weight	0.203 kg (0.45 lb)
Dimensions (H x W x D)	Millimeters: 76 x 94 x 46 Inches: 3.0 x 3.7 x 1.8
Keyswitch Position	3
Standards	
Conformity to Standards	According to DIN EN 50014: 1992 According to DIN EN 50020: 1994 According to DIN EN 50284: 1997 Climatic Conditions according to DIN IEC 721 E.M. Compatibility according to DIN EN 50081-2, DIN EN 50082-2, NAMUR NE 21
CE Conformity (Europe)	To achieve EMC protection class, must use shielded multicore cable with a shield for each channel. The isolation for each channel must be greater than 500V.
Classifications	CENELEC (Europe): II (1) 2G EEx ia/ib IIB/IIC T4

Agency Certification	X  Marked for all applicable directives  DMT 99 ATEX E 031 X
----------------------	--

Terminal Base Connections

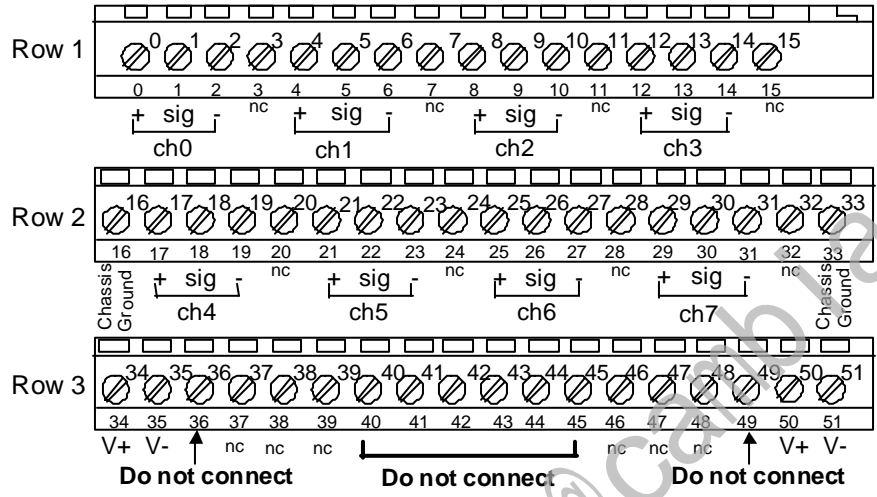

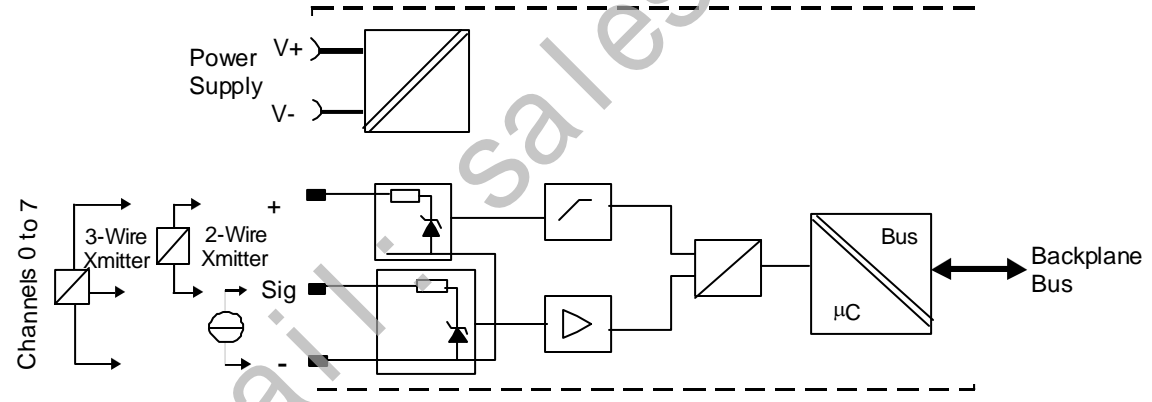

Schematic



Analog Current Input Module (8-Points): TC-PIA082

Parameter	Description
General	
Input Capacity	8 single-ended input channels referenced to a single common
Intrinsically Safe Input	Europe: II (1) 2G EEx ia/ib IIB/IIC T4 (CENELEC)
Input Type	2-Wire and 3-Wire transmitters
Input Functional Data	Input Range: Signal: 4 to 20mA Extended: 2 to 22mA Voltage: >15V @ 22mA
Accuracy	TBD
Temperature Drift	TBD
Response Time	TBD
Resolution	16 Bits
Transmission Characteristics	Vendor Specific Bus – Intrinsically Safe Output Transmission Error @ 293K (20°C/68°F): 0.1% of output signal range Temperature Drift: 0.005%/K of output signal range
Permissible Field Circuit Values	2-Wire Input: TBD
Input Voltage Rating	Intrinsically Safe power supplied through Terminal Base
Power Consumption	0.95 power supply unit load
Power Dissipation	5.2W
Filter Cutoff	TBD
Common Mode Rejection Ratio 50 to 60Hz	TBD
Circuit Fault	Lead Breakage: $I \leq 2\text{mA}$ Short Circuit: $V \leq 4\text{V}$
Lead Breakage Indication	Alarm signal through backplane Bus and channel LED flashing red for fault
Lead Breakage Indication Off (All Channels)	Configurable
Other Configurable Alarms	Overrange Alarm per channel Underrange Alarm per channel Transmitter Alarm per channel for defined fault current Transmitter Lead Breakage Alarm for transmitter open or short circuit, if supported by the transmitter
I/O Terminal Assignments	2-Wire Input: Ch0 – 0,1; Ch1 – 4,5; Ch2 – 8,9; Ch3 – 12,13; Ch4 – 17,18; Ch5 – 21,22; Ch6 – 25,26; Ch7 – 29,30 3-Wire Input: Ch0 – 0,1,2; Ch1 – 4,5,6; Ch2 – 8,9,10; Ch3 – 12,13,14; Ch4 – 17,18,19; Ch5 – 21,22,23; Ch6 – 25,26,27; Ch7 – 29,30,31
Galvanic Isolation (Per DIN EN 50 020)	Input / Backplane Bus Input / Power Supply (There is no galvanic isolation for the inputs relative to each other.)

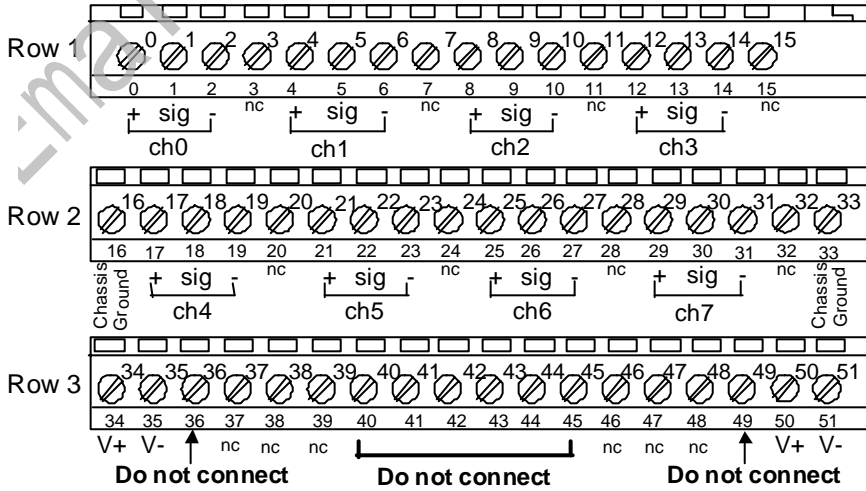
Operating Conditions	
Ambient Temperature	-20°C to 70°C (-4°F to 158°F or 253K to 343K)
Storage Temperature	-20°C to 100°C (-4°F to 212°F or 253K to 373K)
Maximum Relative Humidity	95%, non-condensing
Pollution Gas Test	Test Level G3, according to ISA-S71.04-1985
Shock Test	15g peak 11ms duration
Vibration Test	2g @ 10Hz to 500Hz, according to IEC 68-2-6
Protection Class	IP20 (For installation in the field, a separate housing with protection class IP54 or better is required.)
Physical	
Weight	0.203 kg (0.45 lb)
Dimensions (H x W x D)	Millimeters: 76 x 94 x 46 Inches: 3.0 x 3.7 x 1.8
Keyswitch Position	3
Standards	
Conformity to Standards	According to DIN EN 50014: 1992 According to DIN EN 50020: 1994 According to DIN EN 50284: 1997 Climatic Conditions according to DIN IEC 721 E.M. Compatibility according to DIN EN 50081-2, DIN EN 50082-2, NAMUR NE 21
CE Conformity (Europe)	To achieve EMC protection class, must use shielded multicore cable with a shield for each channel. The isolation for each channel must be greater than 500V.
Classifications	CENELEC (Europe): II (1) 2G EEx ia/ib IIB/IIC T4
Agency Certification	 Marked for all applicable directives  DMT 99 ATEX E 031 X
Terminal Base Connections	
 <p>Row 1: 0 1 2 3 4 5 6 7 8 9 10 11 12 13 14 15 ch0 ch1 ch2 ch3</p> <p>Row 2: 16 17 18 19 20 21 22 23 24 25 26 27 28 29 30 31 32 33 Chassis Ground ch4 ch5 ch6 ch7 Chassis Ground</p> <p>Row 3: 34 35 36 37 38 39 40 41 42 43 44 45 46 47 48 49 50 51 V+ V- nc nc nc Do not connect nc nc nc V+ V- Do not connect Do not connect Do not connect</p>	

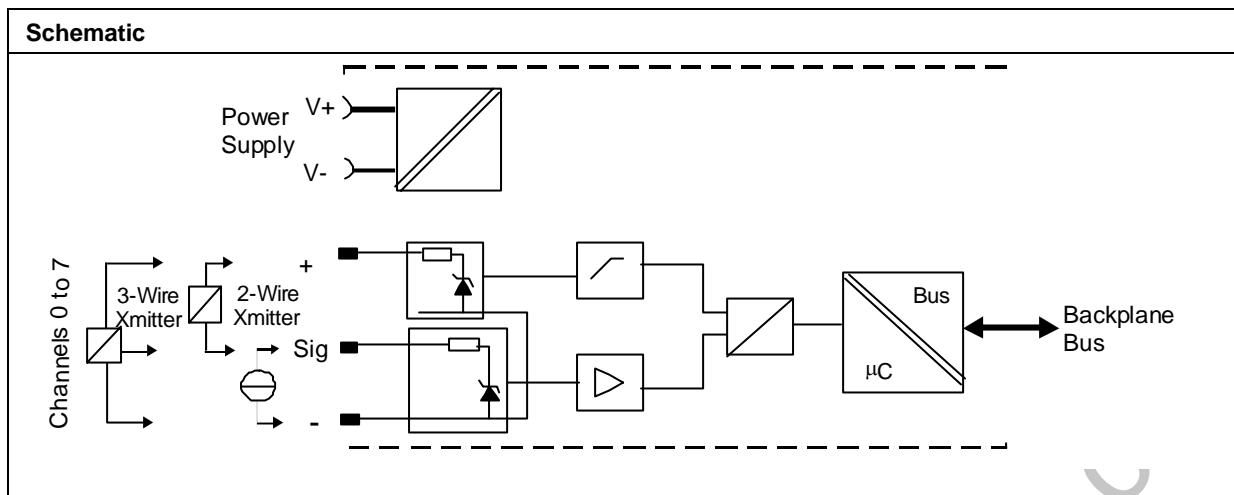



email: sales@cambia.com

Temperature Input Module (8-Points): TC-PIL081

Parameter	Description
General	
Input Capacity	8 input channels referenced to a single common
Intrinsically Safe Input	Europe: II (1) 2G EEx ia/ib IIB/IIC T4 (CENELEC)
Input Type	Configurable for input channel groups 0 to 3 and 4 to 7 -- 0.2, 0.5, 1, 2, 3, 10 Hz: Thermocouple, or RTD
Temperature Format	Configurable as Celsius, Fahrenheit, or Kelvin (All Channels)
Thermocouple Input Functional Data (Configurable)	<p>TC Sensor Type: mV/ Range: -40 to 100mV, B/ Range: Not presently supported/ Range:-270 to 1000°C, J/ Range: -210 to 1200°C, K/ Range: -270 to 1372°C, L/ Range: Not presently supported, N/ Range: -270 to 1300°C, R/ Range: -50 to 1768°C, S/ Range: -50 to 1768°C, or T/ Range: -270 to 400°C</p> <p>TC Sensor Modes: No compensation, fixed compensation, nor external compensation supported</p> <p>Reference Temperature: Temperature of CJC reference element or external temperature compensation</p>
RTD Input Functional Data (Configurable)	<p>RTD Sensor Type: Ohm without conversion/ Range 0 to 500 ohms, Pt 100 (IEC 751, Amendment 2)/ Range: -200 to 870°C, Pt 200 (IEC 751, Amendment 2)/ Range: -200 to 380°C, Pt 100 (JIS C1604-1989)/ Range: -200 to 630°C , Pt 200 (JIS C1604-1989)/ Range: -200 to 375°C, Ni100, DIN 43 760-1987/ Range: -60 to 250°C Ni 200 DIN 43 760-1987/ Range: -60 to 200°C Ni120 Minco/ Range: -80 to 320°C, or Cu10 Minco/ Range: -200 to 260°C</p> <p>RTD Sensor Mode: 2-Wire Measurement without compensation of the lead resistance, 2-Wire Measurement with compensation of the lead resistance, 3-Wire Measurement, or 4-Wire Measurement</p> <p>RTD Loop Resistance Offset: Select offset resistance value to compensate for lead resistance</p>
Lead Resistance	<10 ohms per lead (preliminary)
Thermocouple Accuracy	+/- 0.5% of the mV input for TC Sensor Types E, J, K, N +/- 0.8% of the mV input for TC Sensor Types R, S, T
RTD Accuracy	0.1% (maximum) of span for all RTD Sensor Types EXCEPT: +/- 0.125% PT 100 JIS +/- 0.200% Ni 100 +/- 0.15% Ni 200
Linearization Accuracy	+/- 0.2° C maximum
Cold Junction Sensor Accuracy	+/- 0.8° C maximum at 25°C

Cold Junction Sensor Drift	300ppm/C of CJR span for the module temp range of (-20C to -15C) 100ppm/C of CJR span for the module temp range of (-15 to 70C) Note: the span is based on the 120C temp range of the CJR thermistor.								
Response Time	4 ms								
Resolution	16 Bits								
Temperature Drift	RTD except sensor type Cu10 Minco: 100 ppm/°C (K) RTD sensor type Cu10 Minco: 400 ppm/°C (K) Thermocouple:								
	Type	Lower Range		Middle Range		Upper Range		Single Range	
		Range °C	ppm/°C (K)	Range °C	ppm/°C (K)	Range °C	ppm/°C (K)	Range °C	ppm/°C (K)
	B	Not presently supported							
	E	-270 to -201	250			-200 to 1000	100		
	J							-210 to 1200	100
	K	-270 to -251	300	-250 to -171	250	-170 to 1372	100		
	TXK/XK(L) - Not presently supported								
	N	-270 to -251	400	-250 to 181	350	-180 to 1300	100		
	R	-50 to -1	300			0 to 1768	100		
	S	-50 to -1	300			0 to 1768	100		
	T	-270 to -171	600			-170 to 400	100		
	MV							-40 to 100 mV	100

<p>Permissible Field Circuit Values</p>	<p>Input (All Channels): $U_o = 9V$ $I_o = 37mA$ $P_o = 83mW$ L_o : 80mH maximum for EEx ia IIB 20mH maximum for EEx ia IIC C_o : 40μF maximum for EEx ia IIB 4.9 μF maximum for EEx ia IIC L_o/R_o: 1.7 mH/ohm for EEx ia IIB 0.4 mH/ohm for EEx ia IIC Internal CJC: $U_o = 9V$ $I_o = 1mA$ $P_o = 3mW$ L_o : 1H maximum for EEx ia IIB 1H maximum for EEx ia IIC C_o : 40μF maximum for EEx ia IIB 4.9μF maximum for EEx ia IIC L_o/R_o: 63 mH/ohm for EEx ia IIB 15 mH/ohm for EEx ia IIC External CJC: $U_o = 9V$ $I_o = 38mA$ $P_o = 86mW$ L_o : 80mH maximum for EEx ia IIB 20mH maximum for EEx ia IIC C_o : 40μF maximum for EEx ia IIB 4.9μF maximum for EEx ia IIC L_o/R_o: 1.7 mH/ohm for EEx ia IIB 0.4 mH/ohm for EEx ia IIC</p>
<p>Input Voltage Rating</p>	<p>Intrinsically Safe power supplied through Terminal Base</p>
<p>Power Consumption</p>	<p>0.19 power supply unit load</p>
<p>Power Dissipation</p>	<p>1.6W</p>
<p>Filter Cutoff</p>	<p>Configurable</p>
<p>Fault Detection</p>	<p>Configurable – Enables detection of sensor lead breakage or short circuit for channel groups 0 to 3 and 4 to 7</p>
<p>Other Alarms</p>	<p>Overrange Alarm per channel Underrange Alarm per channel Cold Junction Alarm</p>
<p>Galvanic Isolation (Per DIN EN 50 020)</p>	<p>Input / Backplane Bus Input / Power Supply (There is no galvanic isolation for the inputs relative to each other.)</p>

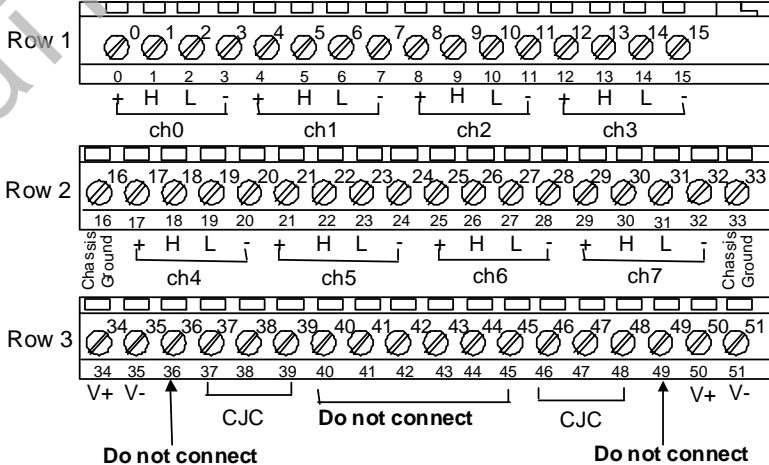

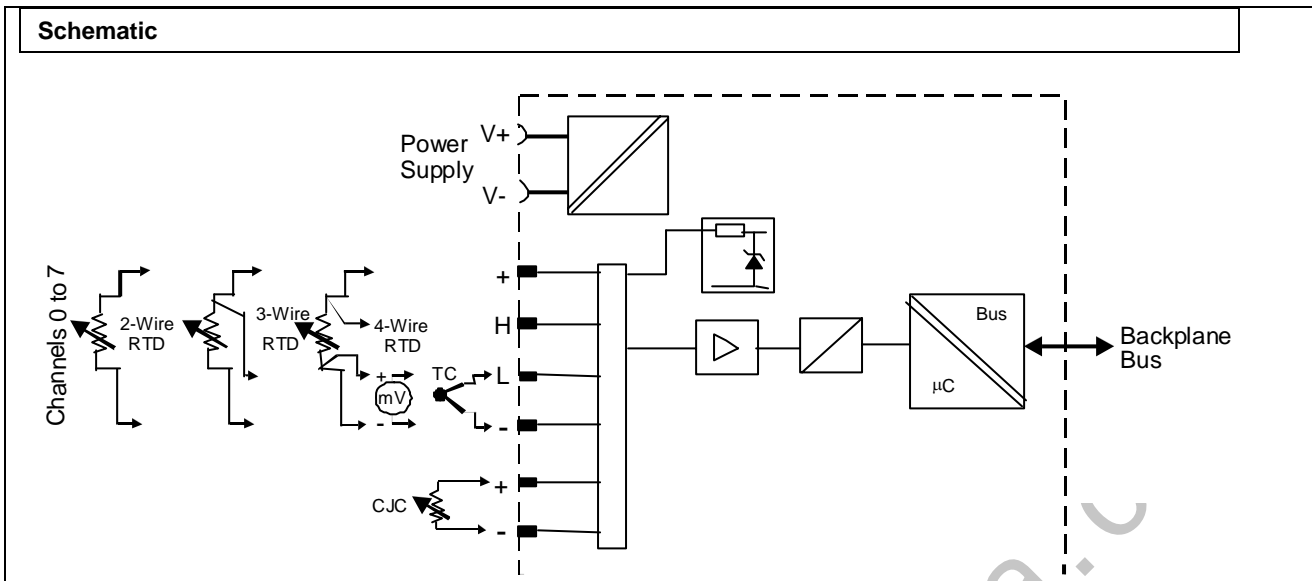
Operating Conditions	
Ambient Temperature	-20°C to 70°C (-4°F to 158°F or 253K to 343K)
Storage Temperature	-20°C to 100°C (-4°F to 212°F or 253K to 373K)
Maximum Relative Humidity	95%, non-condensing
Pollution Gas Test	Test Level G3, according to ISA-S71.04-1985
Shock Test	15g peak 11ms duration
Vibration Test	2g @ 10Hz to 500Hz, according to IEC 68-2-6
Protection Class	IP20 (For installation in the field, a separate housing with protection class IP54 or better is required.)
<i>Physical</i>	
Weight	0.247 kg (0.54 lb)
Dimensions (H x W x D)	Millimeters: 76 x 94 x 46 (With I/O module installed) Inches: 3.0 x 3.7 x 1.8
Keyswitch Position	2
Standards	
Conformity to Standards	According to DIN EN 50014: 1992 According to DIN EN 50020: 1997 According to DIN EN 50284: 1997 Climatic Conditions according to DIN IEC 721 E.M. Compatibility according to DIN EN 50081-2, DIN EN 50082-2, NAMUR NE 21
CE Conformity (Europe)	To achieve EMC protection class, must use shielded multicore cable with a shield for each channel. The isolation for each channel must be greater than 500V.
Classifications	CENELEC (Europe): II (1) 2G EEx ia/ib IIB/IIC T4
Agency Certification	 Marked for all applicable directives  DMT 99 ATEX E-025 X
Terminal Base Connections	
 <p>Row 1: Terminals 0-15, grouped into channels ch0, ch1, ch2, and ch3. Each channel has H and L terminals.</p> <p>Row 2: Terminals 16-33, grouped into channels ch4, ch5, ch6, and ch7. Chassis Ground connections are shown at terminals 16 and 33.</p> <p>Row 3: Terminals 34-51. Labels include V+, V-, CJC, and Do not connect.</p>	



email: sales@cambia.a.c

Digital Input Module (16-Points): TC-PIB161

Parameter	Description
General	
Input Capacity	16 single-ended sinking input channels referenced to a single supply
Intrinsically Safe Input	Europe: II (1) 2G EEx ia/ib IIB/IIC T4 (CENELEC)
Input Type	According to EN 50 227 (NAMUR)
Input Functional Data	Quiescent Voltage / Short-Circuit Current: Approximately 8Vdc / Approximately 8mA Switching Point / Switching Hysteresis 1.2 to 2.1mA / Approximately 0.2mA Input Pulse Length / Pulse Pause >25 μ s / >25 μ s
Response Time	Module Input/Output Delay 1ms all channel
Backplane Bus Update	1 to 64ms depending on filter time setting
Transmission Characteristics	Vendor Specific Bus – Intrinsically Safe Output Maximum Switching Frequency: 1kHz
Permissible Field Circuit Values	U _o = 14.5V I _o = 15mA P _o = 40mW L _o : 10mH maximum for EEx ia IIB 2mH maximum for EEx ia IIC C _o : 1 μ F maximum for EEx ia IIB 300nF maximum for EEx ia IIC L _o /R _o : 2.6 mH/ohm for EEx ia IIB 0.65 mH/ohm for EEx ia IIC
Input Voltage Rating	Intrinsically Safe power supplied through Terminal Base
Power Consumption	0.33 power supply unit load
Power Dissipation	2.8W
Digital Filter Time	Configurable for module – applies to all channels
Circuit Fault	Lead Breakage: I \leq 0.35mA Short Circuit: I \geq 6mA
Lead Breakage Indication	Alarm signal through backplane Bus and channel LED flashing red for fault
Fault Detection Switches	4 DIP switches on bottom of module for enabling/disabling Fault Detection for channel groups 0 to 3, 4 to 7, 8 to 11, and 12 to 15
Galvanic Isolation (Per DIN EN 50 020)	Input / Backplane Bus Input / Power Supply (There is no galvanic isolation for the inputs relative to each other.)
Operating Conditions	
Ambient Temperature	-20°C to 70°C (-4°F to 158°F or 253K to 343K)
Storage Temperature	-20°C to 100°C (-4°F to 212°F or 253K to 373K)
Maximum Relative Humidity	95%, non-condensing
Pollution Gas Test	Test Level G3, according to ISA-S71.04-1985
Shock Test	15g peak 11ms duration

Vibration Test	2g @ 10Hz to 500Hz, according to IEC 68-2-6
Protection Class	IP20 (For installation in the field, a separate housing with protection class IP54 or better is required.)
Physical	
Weight	0.238 kg (0.52 lb)
Dimensions (H x W x D)	Millimeters: 76 x 94 x 46 Inches: 3.0 x 3.7 x 1.8
Keyswitch Position	6
Standards	
Conformity to Standards	According to DIN EN 50014: 1992 According to DIN EN 50020: 1994 According to DIN EN 50284: 1997 Climatic Conditions according to DIN IEC 721 E.M. Compatibility according to DIN EN 50081-2, DIN EN 50082-2, NAMUR NE 21
CE Conformity (Europe)	To achieve EMC protection class, must use shielded multicore cable.
Classifications	CENELEC (Europe): II (1) 2G EEa/ib IIB/IIC T4
Agency Certification	 Marked for all applicable directives  DMT 98 ATEX E 037 X

Terminal Base Connections

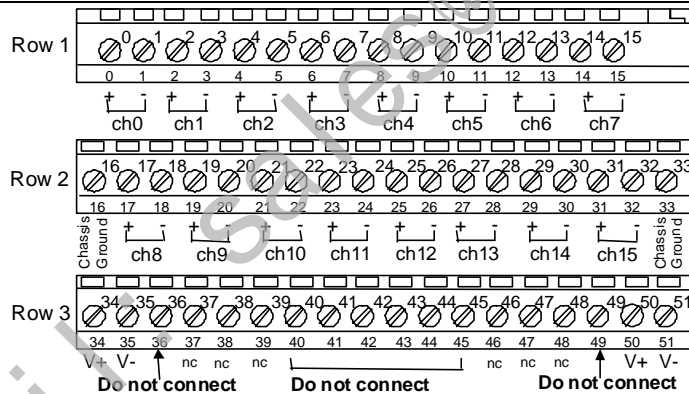

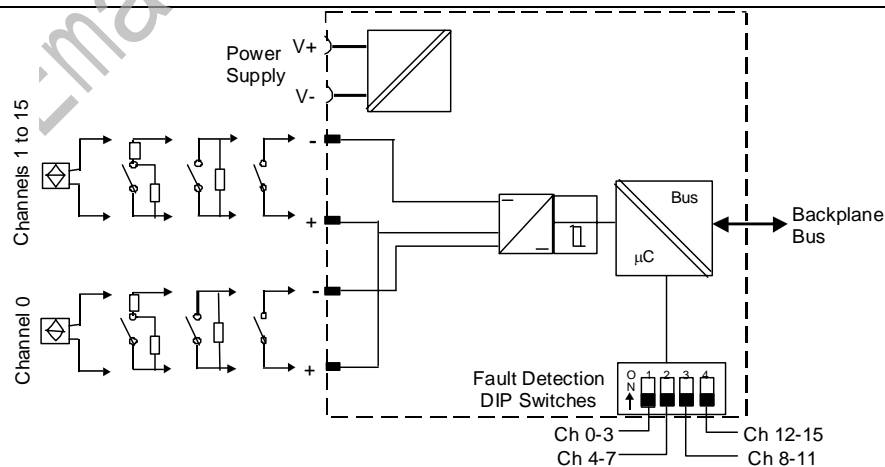

Schematic



13. Output Modules

Analog Output Module (8-Points): TC-POA081

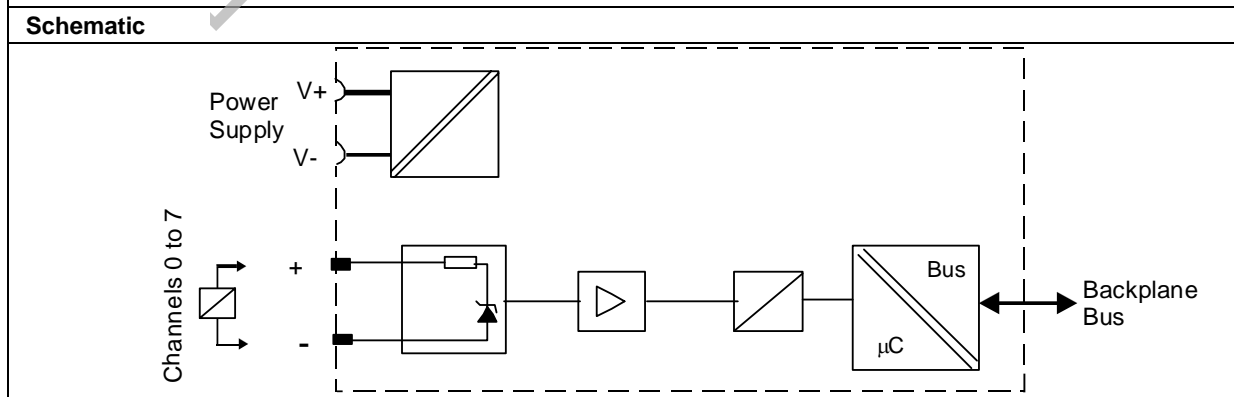
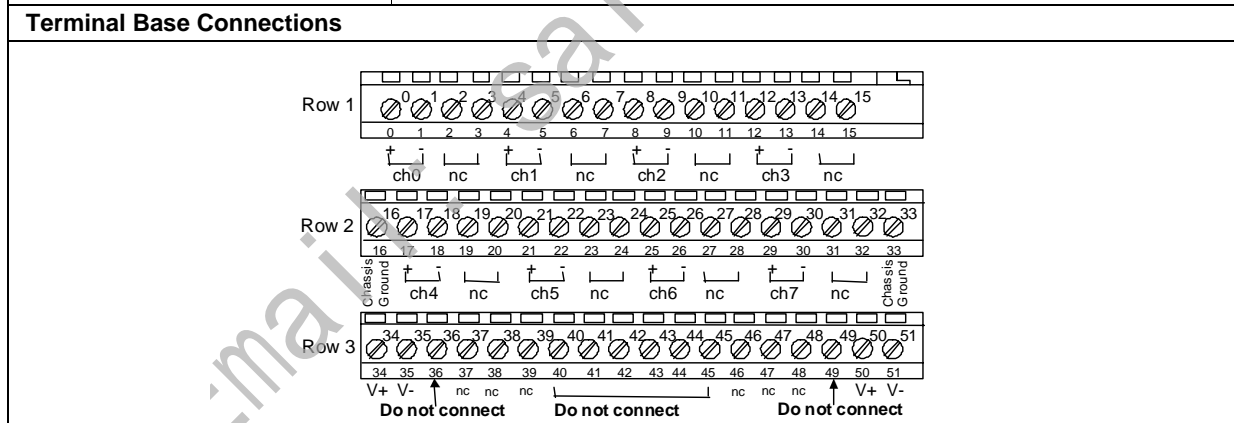

Parameter	Description
General	
Output Capacity	8 dual-ended output channels referenced over sense resistors to a single common
Intrinsically Safe Output	Europe: II (1) 2G EEx ia/ib IIB/IIC T4 (CENELEC)
Output Type	Load: 0 to 500 ohms
Output Functional Data	Output Range: Signal: 4 to 20mA Extended: 2 to 22mA Voltage: >11V @ 22mA
Accuracy	0.1% of signal range
Temperature Drift	100 ppm/°C
Response Time	4ms to 99% of final value
Resolution	13 Bits
Transmission Characteristics	Vendor Specific Bus – Intrinsically Safe Input Transmission Error @ 293K (20°C/68°F): 0.1% of output signal range Temperature Drift: 0.01%/K of output signal range
Permissible Field Circuit Values	2-Wire Output: U _o = 21V I _o = 93mA P _o = 520mW L _o 10mH maximum for EEx ia IIB 3mH maximum for EEx ia IIC C _o : 1.27 uF maximum for EEx ia IIB 188 nF maximum for EEx ia IIC
Input Voltage Rating	Intrinsically Safe power supplied through Terminal Base
Power Consumption	0.77 power supply unit load
Power Dissipation	5.4W
Circuit Fault	Lead Breakage: I ≤ 2mA
Lead Breakage Indication	Alarm signal through backplane Bus and channel LED flashing red for fault
Lead Breakage Detection Off	Configurable for channel groups 0-1, 2-3, 4-5, and 6-7
Latch Mode	Configurable for channel groups 0-3 and 4-7
I/O Terminal Assignments	2-Wire Output: Ch0 – 0,1; Ch1 – 4,5; Ch2 – 8,9; Ch3 – 12,13; Ch4 – 17,18; Ch5 – 21,22; Ch6 – 25,26; Ch7 – 29,30
Galvanic Isolation (Per DIN EN 50 020)	Output / Backplane Bus Output / Power Supply (There is no galvanic isolation for the outputs relative to each other.)
Operating Conditions	
Ambient Temperature	–20°C to 70°C (–4°F to 158°F or 253K to 343K)
Storage Temperature	–20°C to 100°C (–4°F to 212°F or 253K to 373K)
Maximum Relative Humidity	95%, non-condensing

Pollution Gas Test	Test Level G3, according to ISA-S71.04-1985
Shock Test	15g peak 11ms duration
Vibration Test	2g @ 10Hz to 500Hz, according to IEC 68-2-6
Protection Class	IP20 (For installation in the field, a separate housing with protection class IP54 or better is required.)
Physical	
Weight	0.274 kg (0.60 lb)
Dimensions (H x W x D)	Millimeters: 76 x 94 x 46 Inches: 3.0 x 3.7 x 1.8
Keyswitch Position	4
Standards	
Conformity to Standards	According to DIN EN 50014: 1992 According to DIN EN 50020: 1994 According to DIN EN 50284: 1997 Climatic Conditions according to DIN IEC 721 E.M. Compatibility according to DIN EN 50081-2, DIN EN 50082-2, NAMUR NE 21
CE Conformity (Europe)	To achieve EMC protection class, must use shielded multicore cable with a shield for each channel. The isolation for each channel must be greater than 500V.
Classifications	CENELEC (Europe): II (1) 2G EEx ia/ib IIB/IIC T4
Agency Certification	 Marked for all applicable directives  DMT 99 ATEX E 027 X

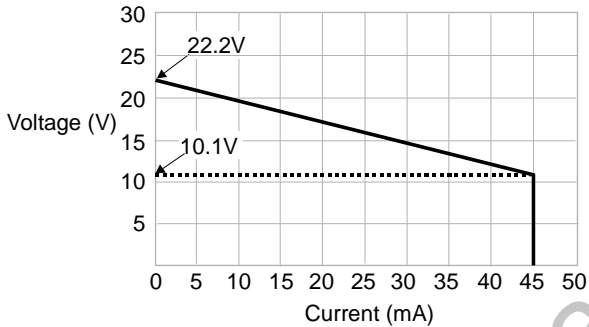

Digital Output Module (4-Points): TC-POB041

Parameter	Description
General	
Output Capacity	4 output channels referenced to a single supply
Intrinsically Safe Output	Europe: II (1) 2G EEx ia/ib IIB/IIC T4 (CENELEC)
Output Type	Output Characteristic Curve:  Load: 30 to 500 ohms
Output Functional Data	Voltage = 11V bei Current = 45mA
Output Failure State	De-energized state
Response Time	Module Input/Output Delay 1ms all channels
Transmission Characteristics	Vendor Specific Bus – Intrinsically Safe Input Switching Frequency: 10kHz
Permissible Field Circuit Values	U _o = 27.4V I _o = 110mA L _o : 8mH maximum for EEx ia IIB 2mH maximum for EEx ia IIC C _o : 677nF maximum for EEx ia IIB 87nF maximum for EEx ia IIC
Input Voltage Rating	Intrinsically Safe power supplied through Terminal Base
Power Consumption	One power supply unit load
Power Dissipation	5W
Fault Detection Delay Time	Configurable for module – applies to all channels
Circuit Fault	Lead Breakage Short Circuit
Fault Indication	Alarm signal through backplane Bus and channel LED flashing red for fault
Latch Mode	Configurable for module – applies to all channels
Galvanic Isolation (Per DIN EN 50 020)	Output / Backplane Bus Output / Power Supply (There is no galvanic isolation for the outputs relative to each other.)
Operating Conditions	
Ambient Temperature	-20°C to 70°C (-4°F to 158°F or 253K to 343K)
Storage Temperature	-20°C to 100°C (-4°F to 212°F or 253K to 373K)
Maximum Relative Humidity	95%, non-condensing
Pollution Gas Test	Test Level G3, according to ISA-S71.04-1985
Shock Test	15g peak 11ms duration

Vibration Test	2g @ 10Hz to 500Hz, according to IEC 68-2-6
Protection Class	IP20 (For installation in the field, a separate housing with protection class IP54 or better is required.)
Physical	
Weight	0.282 kg (0.62 lb)
Dimensions (H x W x D)	Millimeters: 76 x 94 x 46 ; Inches: 3.0 x 3.7 x 1.8
Keyswitch Position	7
Standards	
Conformity to Standards	According to DIN EN 50014: 1992 According to DIN EN 50020: 1994 According to DIN EN 50284: 1997 Climatic Conditions according to DIN IEC 721 E.M. Compatibility according to DIN EN 50081-2, DIN EN 50082-2, NAMUR NE 21
CE Conformity (Europe)	To achieve EMC protection class, must use shielded multicore cable.
Classifications	CENELEC (Europe): II (1) 2G EEx ia/ib IIB/IIC T4
Agency Certification	 Marked for all applicable directives  DMT 99 ATEX E 026 X

Terminal Base Connections

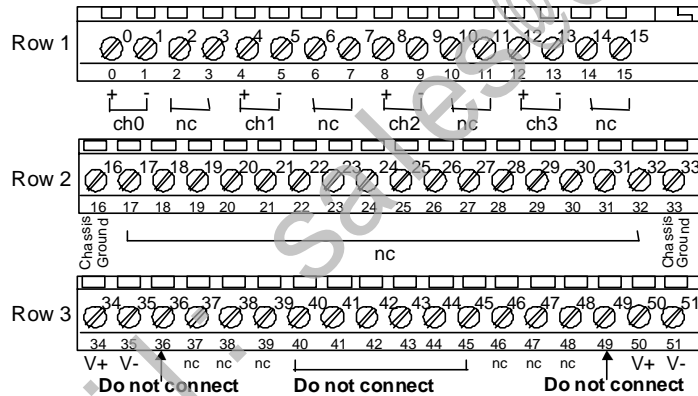

Schematic

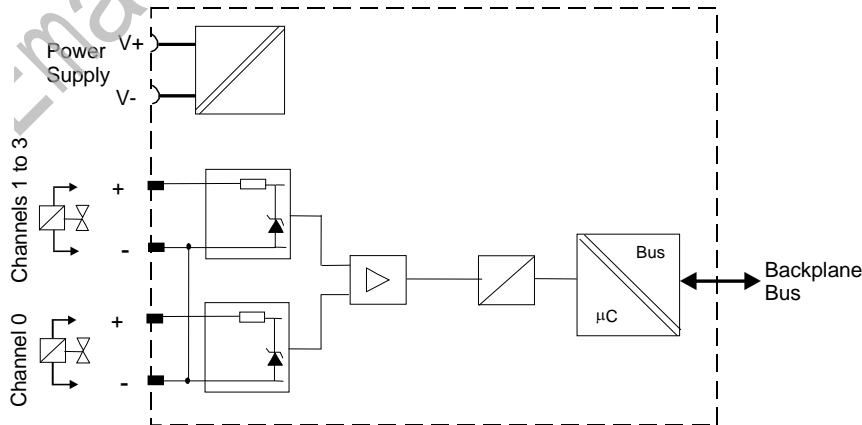

14. Power Supply Dimensional Specifications

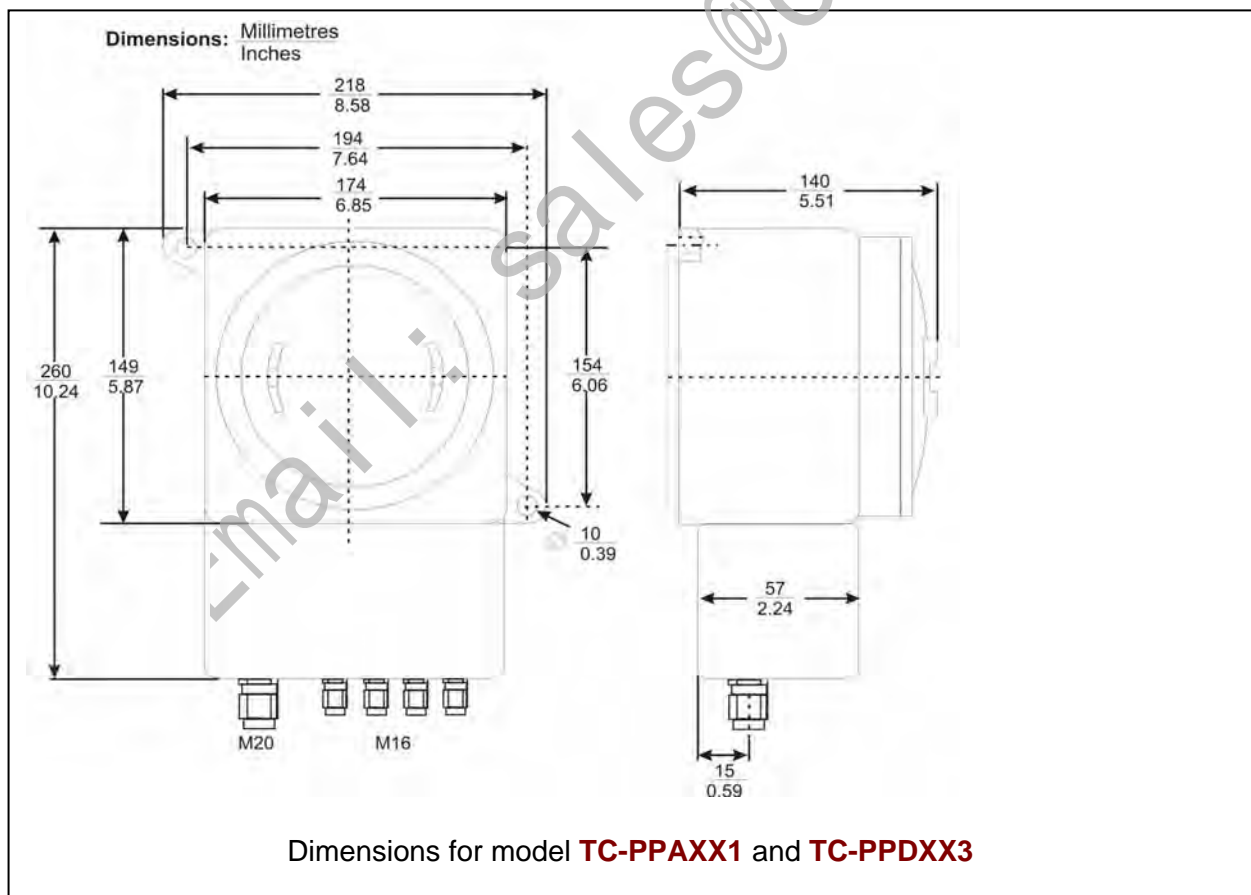
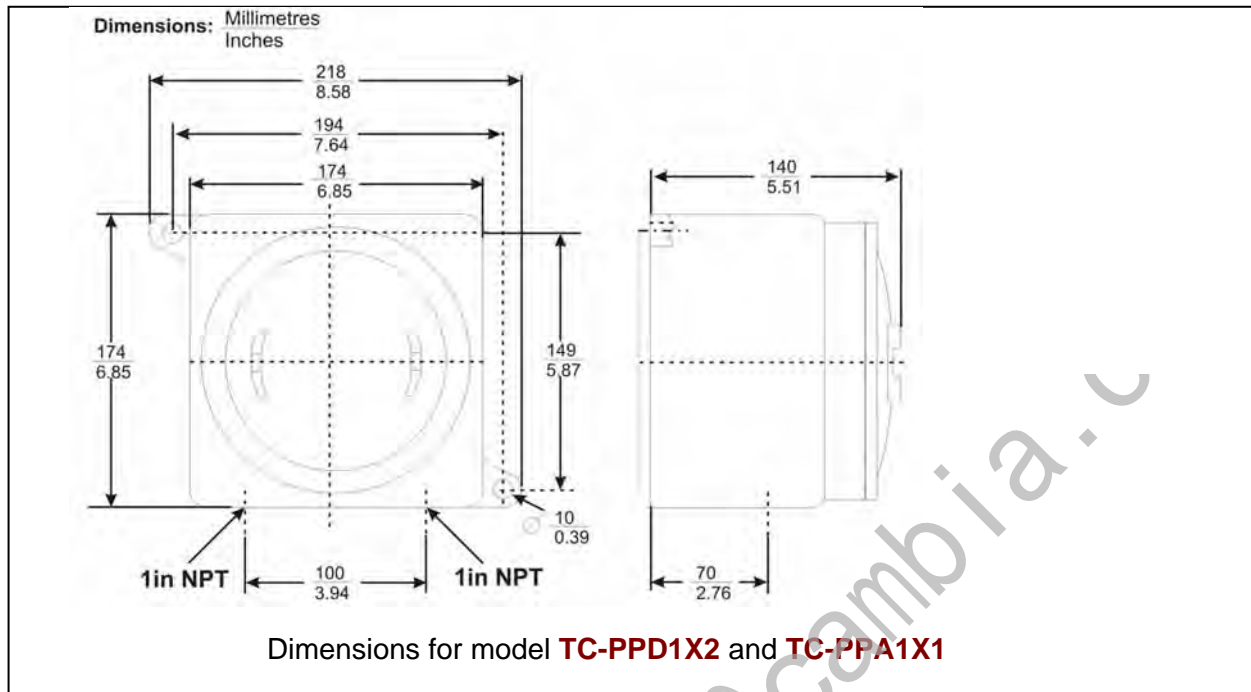

14.1 Power Supply Wiring Diagrams

DC Supplies- TC-PPDXX3 and TC-PPD1X2

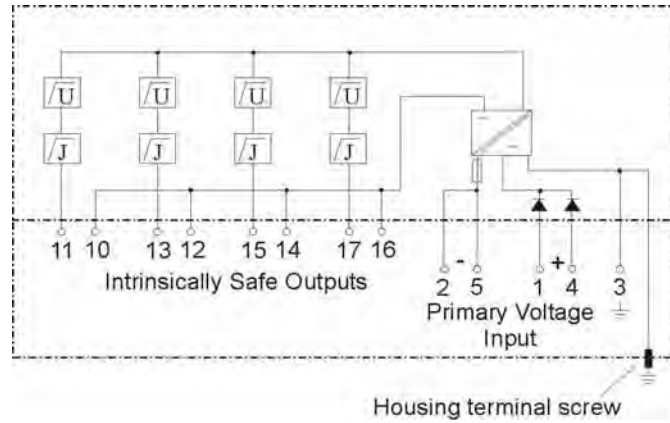

AC Supplies- TC-PPAXX1 and TC-PPA1X1

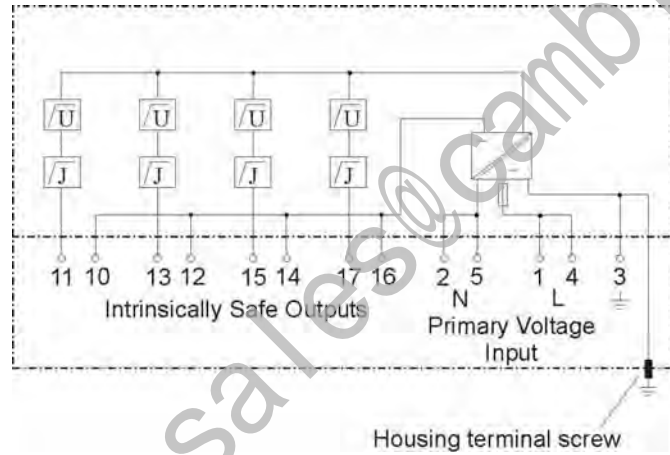

Intrinsically safe output wiring all power supply types:

Output 1		Output 2		Output 3		Output 4	
-	+	-	+	-	+	-	+
11	10	13	12	15	14	17	16

15. Hazardous Locations Reference

North American Classification of Hazardous Locations

Electrical Codes

Installation of electrical apparatus within hazardous (classified) locations of the United States is conducted under the provisions of the National Electrical Code (NEC), ANSI/NFPA 70, Article 500; and within Canada, under the provisions of the Canadian Electrical Code (CEC) C22.1, Part 1, Section 18.

Classifications

In both the United States and Canada, hazardous locations are classified into one of these three classes.

Class	Description of Hazardous Location
I	Presence of flammable gases or vapors may be present in quantities sufficient to produce explosive or ignitable mixtures.
II	Presence of combustible dusts, powders or grains.
III	Presence of easily ignitable fibers or flyings.

Divisions

The classes listed above are further classified into one of the following divisions based upon the level of risk present.

Division	Description of Risk
1	Locations in which hazardous concentrations of flammable gases or vapors, or combustible dust in suspension are continuously, intermittently or periodically present under normal operating conditions.
2	Locations in which flammable gases or vapors are present, but normally confined within closed containers or systems from which they can escape only under abnormal or fault conditions. Combustible dusts are not normally in suspension nor likely to be thrown into suspension.

For example, A **Class III, Division 1** location is a location in which easily ignitable fibers or material processing combustible flyings are handled, manufactured or used. A **Class III, Division 2** location is a location in which easily ignitable fibers are stored or handled.

Groups

Flammable gases, vapors and ignitable dusts, fibers and flyings are classified into one of the following groups according to the energy required to ignite the most easily-ignitable mixture within air.

Class I Group	Description of Atmosphere
A	Atmospheres containing acetylene.
B	Atmospheres containing hydrogen, fuel and combustible process gases containing more than 30 percent hydrogen by volume, or gases or vapors of equivalent hazard
C	Atmospheres such as ethyl ether, ethylene, or gasses or vapors of equivalent hazard.
D	Atmospheres such as acetone, ammonia, benzene, butane, cyclopropane, ethanol, gasoline, hexane, methanol, methane, natural gas, naphtha, propane or gases or vapors of equivalent hazard
Class II	Description

Group	
E	Atmospheres containing combustible metal dusts including aluminum, magnesium, and their commercial alloys, and other metals of similarly hazardous characteristics.
F	Atmospheres containing combustible carbonaceous dusts including carbon black, charcoal, coal or other dusts that have been sensitized by other materials so that they present an explosion hazard.
G	Atmospheres containing combustible dusts not included in Group E or F, including flour wood, grain, and other dusts of similarly hazardous characteristics.

Methods of Protection

The following table summarizes available methods of protection for use in given locations.

Protection Concept	Designation	Permitted Use	Principle
Explosionproof	XP	Division 1 & 2	Contains explosion and quenches flame.
Intrinsic Safety	IS	Division 1 & 2	Limit energy of sparks under normal and fault conditions.
Pressurized	Type X and Y	Division 1	Keeps flammable gas out.
Pressurized	Type Z	Division 2	Keeps flammable gas out.
Nonincendive	NI	Division 2	No arcs, sparks or hot surfaces under normal conditions.

Temperature Classification

Equipment intended for installation directly within the hazardous location classification must also be classified for the maximum surface temperature that can be generated under normal or fault conditions as referenced to either 40°C (104°F) or the maximum operating ambient of the equipment (whichever is greater). The maximum surface temperature must be less than the minimum autoignition temperature of the hazardous atmosphere present. The temperature shall be indicated in identification numbers as listed in the following table.

Temperature Identification Number	Maximum Temperature	
	Degrees C	Degrees F
T1	450	842
T2	300	572
T2A	280	536
T2B	260	500
T2C	230	446
T2D	215	419
T3	200	392
T3A	180	356
T3B	165	329
T3C	160	320
T4	135	275
T4A	120	248
T5	100	212
T6	85	185

Apparatus Parameters

The Intrinsically Safe Apparatus Parameters are defined as follows.

Parameter	Description
V_{max} (Ui)	Maximum safe voltage which can be applied to the apparatus terminals.
I_{max} (Ii)	Maximum safe current which can be applied to the apparatus terminals.
C_i	Unprotected capacitance in the apparatus which can be considered present at the terminals.
L_i	Unprotected inductance in the apparatus which can be considered present at the terminals.

The Associated Apparatus Parameters are defined as follows.

Parameter	Description
V_{oc} (Uo)	Maximum output voltage which can be delivered to the hazardous (classified) location. This voltage is the maximum from a single channel.
I_{sc} (Io)	Maximum output current which can be delivered to the hazardous (classified) location. This current is the maximum from a single channel.
* V_t	Maximum output voltage which can be delivered to the hazardous (classified) location. This voltage is the maximum across any combination of terminals of a multiple channel configuration.
* I_t	Maximum output current which can be delivered to the hazardous (classified) location. This current is the maximum through any combination of terminals of a multiple channel configuration.
C_a (Co)	Maximum capacitance which can be connected to the apparatus.
L_a (Lo)	Maximum inductance which can be connected to the apparatus.

*CSA does not recognize these parameters at this time.

15.1 Entity Concept

A field device mounted in the hazardous area, such as a transmitter, must be certified if it is capable of storing energy. However, if it is a “simple device” or “non-voltage producing” device that neither generates nor stores significant energy, no certification of the field device is required. A thermocouple is an example of a “simple device.”

The Entity concept allows interconnection of intrinsically safe apparatus to associated apparatus not specifically examined in such combination. The criteria for interconnection is that the voltage (V_{max}) and current (I_{max}), which intrinsically safe apparatus can receive and remain intrinsically safe, considering faults, must be equal to or greater than the voltage (V_{oc} or V_t) and current (I_{sc} or I_t) levels which can be delivered by the associated apparatus, considering faults and applicable factors.

In addition, the maximum unprotected capacitance (C_i) and inductance (L_i) of the intrinsically safe apparatus, including interconnecting wiring, must be less than or equal to the capacitance (C_a) and inductance (L_a) which can be safely connected to the associated apparatus. Field wiring has distributed capacitance and inductance capable of releasing energy. Because IS requirements are concerned with the amount of energy that can be released from circuits in a hazardous area, the stored energy in the distributed inductance and capacitance of the cable must be considered in determining the length of the field wiring. If these criteria are met, then the combination may be connected and remain intrinsically safe.

The following table summarizes the maximum values that are permissible for the given RIOM-H component field circuits.

15.2 International Electrotechnical Commission Classification of Hazardous Locations

About IEC

The International Electrotechnical Commission (IEC) has established a number of recommendations applying to the construction of explosion protected electrical apparatus identified. These recommendations are found within IEC 79-0 through 79-15 and 79-28.

For all EC countries as well as various neighboring countries (CENELEC member states), the European Standards EN 50 014 to EN 50 020 and EN 50 039 apply for the construction of explosion protected electrical apparatus. They were established on the basis of the IEC. However these recommendations are much more detailed by comparison.

Zones

Within IEC7-10, hazardous locations are classified into one of these three zones.

ZONE	Description of Hazardous Location
0	Explosive gas atmosphere is present continuously, or is present for long periods.
1	Explosive gas atmosphere is likely to occur in normal operation.
2	Explosive gas atmosphere is not likely to occur in normal operation and, if it does occur, it will exist for a short period only.

IEC Groups

Flammable gases, vapors and mists are further classified into groups according to the energy required to ignite the most easily-ignitable mixture within air. Apparatus is grouped according to the atmospheres it may be used within as follows:

Group	Description of Atmosphere
IIC	Atmospheres containing acetylene, hydrogen, fuel and combustible process gases or vapors of equivalent hazard.
IIB	Atmospheres such as ethyl ether, ethylene, or gasses or vapors of equivalent hazard.
IIA	Atmospheres such as acetone, benzene, butane, cyclopropane, ethanol, gasoline, hexane, methanol, methane, natural gas, naphtha, propane or gases or vapors of equivalent hazard.

IEC Methods of Protection

The following table summarizes available methods of protection for use in given locations.

Protection Concept	Designation	Permitted Use	Principle
Flameproof	d	Zone 1 & 2	Contains explosion and quenches flame.
Intrinsic Safety	ia	Zone 0, 1 & 2	Limits energy of sparks under 2 faults.
	ib	Zone 1 & 2	Limits energy of sparks under 1 fault
Pressurized	p	Zone 1	Keeps flammable gases out.
Encapsulation	m	Zone 1 & 2	Keeps flammable gases out.
Increased Safety	e	Zone 1 & 2	No arcs, sparks or hot surface.
Powder Filled	q	Zone 1 & 2	Contains explosion and quenches flame.
Oil Immersion	o	Zone 1 & 2	Keeps flammable gases out.
Non-sparking	nA	Zone 2	No arcs, sparks or hot surfaces under normal conditions.
Enclosed Break	nC	Zone 2	Contains explosion and quenches flame.
Limited Energy	nA	Zone 2	Limits energy of sparks and surface temperature under normal conditions.
Restricted Breathing	nR	Zone 2	Keeps flammable gases out.

IEC Temperature Classification

Equipment intended for installation directly within the hazardous location must also be classified for the maximum surface temperature that can be generated under normal or fault conditions as referenced to the maximum operating ambient of the equipment. The maximum surface temperature must be less than the minimum autoignition temperature of the hazardous atmosphere present. The temperature shall be indicated in identification numbers as listed in the following table.

Temperature Identification Number	Maximum Temperature	
	Degrees C	Degrees F
T1	450	842
T2	300	572
T3	200	392
T4	135	275
T5	100	212
T6	85	185

15.3 Enclosure Ratings

The NEMA (National Electrical Manufacturer's Association) enclosure classifications are recognized in the US. The IEC Publication 529 Enclosure Classifications are recognized throughout Europe and those parts of the world that use the IEC standards as a basis for product certifications.

NEMA and IEC Comparison

IEC Publication 529, *Classification of Degrees of Protection Provided by Enclosures*, provides a system for specifying the enclosures of electrical equipment on the basis of the degree of protection provided by the enclosure. IEC 529 does not specify degrees of protection against mechanical damage of equipment, risk of explosion, or conditions such as moisture (produced for example by condensation), corrosive vapors, fungus, or vermin. NEMA Standards Publication 250, *Enclosures for Electrical Equipment (1000 Volts Maximum)*, does test for environmental conditions such as corrosion, rust, icing, oil, and coolants. For this reason, and because the tests and evaluations for other characteristics are not identical, the IEC enclosure classification designations cannot be exactly equated with NEMA enclosure type numbers.

Basically, the IEC designation consists of the letters IP followed by two numerals. The first characteristic numeral indicates the degree of protection provided by the enclosure with respect to persons and solid foreign objects entering the enclosure. The second characteristic numeral indicates the degree of protection provided by the enclosure with respect to the harmful ingress of water.

The table below provides an approximate conversion from NEMA enclosure type numbers to IEC enclosure classification designations. The NEMA types meet or exceed the test requirements for the associated IEC classifications; for this reason the Table cannot be used to convert from IEC classifications to NEMA types.

NEMA Enclosure Type Number	IEC Enclosure Classification Designation
1	IP 10
2	IP 11
3	IP 54
3R	IP 14
3S	IP 54
4 and 4X	IP 56
5	IP 52
6 and 6P	IP 67
12 and 12K	IP 52
13	IP 54

NOTE: This comparison is based on tests specified in IEC Publication 529.

email: sales@cambia.com

Experion, PlantScape and TotalPlant are registered trademarks of Honeywell International Inc. All other products and brand names shown are trademarks of their respective owners.

While this information is presented in good faith and believed to be accurate, Honeywell disclaims the implied warranties of merchantability and fitness for a particular purpose and makes no express warranties except as may be stated in its written agreement with and for its customer. In no event is Honeywell liable to anyone for any indirect, special or consequential damages. The information and specifications in this document are subject to change without notice.

This document that is published for the sole usage of Honeywell Process Solutions' customers and prospective customers

For More Information

Learn more about Honeywell's Experion LS, visit our website www.honeywellprocess.com/Experion-LS or contact your Honeywell account manager.

Honeywell Process Solutions

1860 West Rose Garden Lane

Phoenix, AZ 85027

Tel: 800-822-7673

www.honeywellprocess.com

EP03-110-400, V2

February 2012

© 2011-12 Honeywell International Inc.

The Honeywell logo is displayed in a bold, red, sans-serif font.